

Characteristics

Hydraulically operated directional control valves are available in 5 sizes:

- D1VP*4L NG06 – operated via end caps
- D1VP*90 NG06 – operated via end caps and mounting interface (X, Y)
- D3DP NG10 – operated via mounting interface (X, Y)
- D4P NG16 – operated via mounting interface (X, Y)
- D9P NG25 – operated via mounting interface (X, Y)
- D11P NG32 – operated via mounting interface (X, Y)

Size NG06 (D1VP) is available in two different designs:

- D1VP*4L for operating pressure >10 bar (over tank pressure) with control ports in the end caps.
- D1VP*90 for operating pressure >15 bar with control ports in the end caps and mounting interface (X, Y).

All other series are operated only via mounting interface (X, Y).

The shifting time is depending on the pilot pressure. For safe operation the minimum pilot pressure has to be ensured in all operating conditions. The maximum pilot pressure varies from the maximum operating pressure in some sizes.

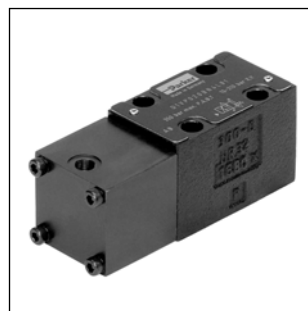

D1VP*B*4L

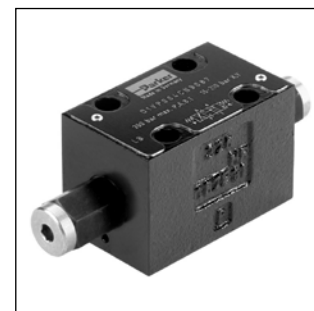

D1VP*90

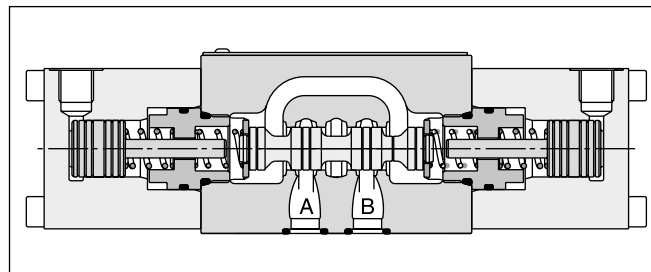

D1VP*C*4L

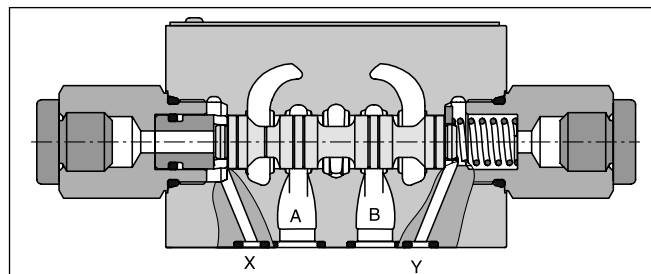

D1VP*90

Technical data

General		Directional spool valve					
Design		Directional spool valve					
Actuation		Hydraulic					
Series		D1VP*4L	D1VP*90	D3DP	D4P	D9P	D11P
Size		NG06	NG06	NG10	NG16	NG25	NG32
Weight	[kg]	1.3	1.3	3.7	9.0	17.0	66.0
Mounting interface		DIN 24340 A06 ISO 4401 NFFPA D03	DIN 24340 A06 ISO 4401 NFFPA D03	DIN 24340 A10 ISO 4401 NFFPA D05	DIN 24340 A16 ISO 4401 NFFPA D07	DIN 24340 A25 ISO 4401 NFFPA D08	DIN 24340 A32 ISO 4401 NFFPA D10
		CETOP RP 121-H					
Mounting position		unrestricted, preferably horizontal					
Ambient temperature	[°C]	-25...+60					
MTTF ₀ value	[years]	150					
Hydraulic							
Max. operating pressure	[bar]	P, A B: 350; T: 140	P, A B; T: 350; X, Y: 210	P, A B, T: 350; X, Y: 210	P, A B, T: 350; X, Y: 350	P, A B, T: 350; X, Y: 350	P, A B, T: 350; X, Y: 350
Fluid		Hydraulic oil according to DIN 51524					
Fluid temperature	[°C]	-20 ... +70 (NBR: -25...+70)					
Viscosity permitted	[cSt] / [mm ² /s]	2.8...400					
Viscosity recommended	[cSt] / [mm ² /s]	30...80					
Filtration		ISO 4406 (1999); 18/16/13					
Flow max.	[l/min]	60 ¹⁾	60 ¹⁾	130	300	700	2000
Leakage at 350 bar (per flow path)	[ml/min]	up to 60 ²⁾	up to 60 ²⁾	up to 100 ²⁾	up to 200 ²⁾	up to 800 ²⁾	up to 5000 ²⁾
Operating pressure (min/max)	[bar]	10 ³⁾ / 210	15 / 210	15 / 210	5 / 350	5 / 350	5 / 350
Pilot volume (start position to end position)	[cm ³]	0.59	0.34	1.1	4.2	12.3	59.7
Static / Dynamic							
Step response		The response times depend on the pilot oil pressure and on the speed of the increase / decrease of the pilot pressure.					

¹⁾ Depending on spool, see shift limits.

²⁾ Depending on spool.

³⁾ > tank pressure.

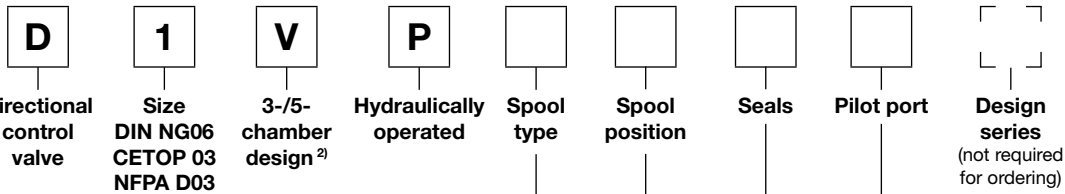

2

3 position spools	
Code	Spool type
	a 0 b
001	
002	
004	
006	
008 ¹⁾	
009 ¹⁾	

2 position spools	
Code	Spool type
	a b
020	
026	
030	

Code	Pilot port
4L	High tank pressure, indirect operated via pilot spool, 3-chamber
90	Direct operated via X, Y port or pipe thread G1/4, 5-chamber

Code	Seals
N	NBR
V	FPM

3 position spools ³⁾		
Code	Spool position	
C		3 positions. Spring offset in position "0". Operated in position "a" or "b".
	Standard	Spool type 008 and 009
E	 Operated in position "a".	 Operated in position "b".
F	 Spring offset in position "b".	 Spring offset in position "a".
K	 Operated in position "b".	 Operated in position "a".
M	 Spring offset in position "a".	 Spring offset in position "b".

2 position spools ³⁾		
Code	Spool position	
B		Spring offset in position "b". Operated in position "a".
D		Detent, operated in position "a" or "b". No centre or offset position.
H		Spring offset in position "a". Operated in position "b".

¹⁾ Consider specific spool position.
²⁾ Depending on pilot port.
³⁾ Code 4L without ports X and Y.

Further spool types and styles on request.

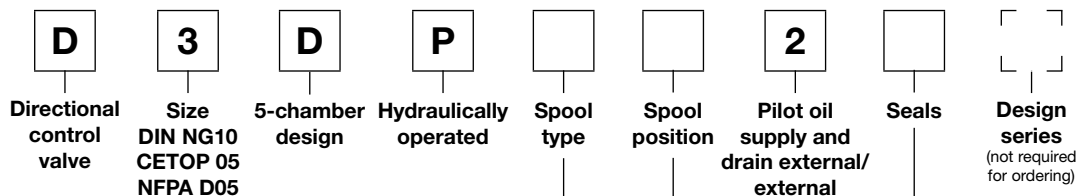

2

3 position spools	
Code	Spool type
001	
002	
003	
004	
005	
006	
007	
008 ¹⁾	
009 ¹⁾	
010	
011	
014	
015	
016	
021	
022	
031	
032	
081	
082	
102	

2 position spools	
Code	Spool type
020	
026	
030	
101	

Code	Seals
N	NBR
V	FPM

3 position spools		
Code	Spool position	
C		3 positions. Spring offset in position "0". Operated in position "a" or "b".
	Standard	Spool type 008 and 009
E		2 positions. Spring offset in position "0".
F		2 positions. Operated in position "0".
K		2 positions. Spring offset in position "0".
M		2 positions. Operated in position "0".

2 position spools		
Code	Spool position	
B		Spring offset in position "b". Operated in position "a".
D		Detent, operated in position "a" or "b". No center or offset position.
H		Spring offset in position "a". Operated in position "b".

¹⁾ Consider specific spool position.

Further spool types and styles on request.

2

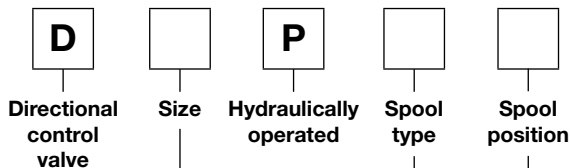

Code	Bore	Size
4	Ø20 mm	NG16
9	Ø32 mm	NG25
11	Ø50 mm	NG32

3 position spools		D4	D9	D11
Code	Spool type			
	a 0 b			
001		•	•	•
002		•	•	•
003		•	•	
004		•	•	•
005		•	•	
006		•	•	
007		•	•	
009 ¹⁾		•	•	•
011		•	•	
014		•	•	
015		•	•	
016		•	•	
021		•	•	
022		•	•	
031			•	
032			•	
054		•	•	•
081		•	•	•
082		•	•	•

2 position spools		D4	D9	D11
Code	Spool type			
	a b			
020		•	•	•
026		•	•	
030		•	•	•

3 position spools		
Code	Spool position	
C		3 positions. Spring offset in position "0". Operated in position "a" or "b".
	Standard	Spool type 009
E		2 positions. Spring offset in position "0".
	Operated in position "a".	Operated in position "b".
F		2 positions. Operated in position "0".
	Spring offset in position "b".	Spring offset in position "a".
K		2 positions. Spring offset in position "0".
	Operated in position "b".	Operated in position "a".
M		2 positions. Operated in position "0".
	Spring offset in position "a".	Spring offset in position "b".
R ²⁾		2 positions detent. Operated in position "0" or "b".
	No centre in offset position.	No centre in offset position.
S ²⁾		2 positions detent. Operated in position "0" or "a". No center in offset position.
	No centre in offset position.	No centre in offset position.

2 position spools		
Code	Spool position	
B		Spring offset in position "b". Operated in position "a".
D		Detent, operated in position "a" or "b". No centre or offset position.
H		Spring offset in position "a". Operated in position "b".

¹⁾ Consider specific spool position.

²⁾ Only D4 and D9 available.

Ordering Code

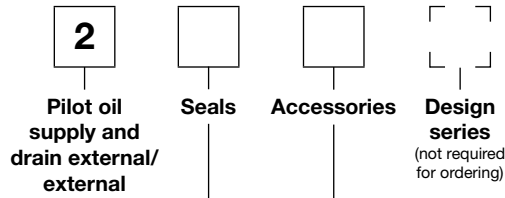

2

Code	Accessories
omit	Standard valve w/o accessories
3A	Pilot choke, meter-out
3B	Pilot choke, meter-in
3D ²⁾	Stroke adjustment side B
3E ²⁾	Stroke adjustment side A
3F ²⁾	Stroke adjustment side A and B

Code	Seals
N	NBR
V	FPM

Further spool types, styles and position control on request.

Flow Curve Diagrams / Shift Limits

The flow curve diagram shows the flow versus pressure drop curves for all spool types. The relevant curve

number for each spool type, operating position and flow direction is given in the table below.

Spool	Position „b“		Position „a“		Position „0“				
	P->A	B->T	P->B	A->T	P->A	P->B	A->T	B->T	P->T
001	2	2	2	2	-	-	-	-	-
002	1	4	1	4	1	1	5	5	2
004	2	3	2	3	-	-	7	7	-
006	1	4	1	4	7	7	-	-	-
020	4	4	2	3	-	-	-	-	-
026	4	-	4	-	-	-	-	-	-
030	2	3	1	2	-	-	-	-	-
	P->B	A->T	P->A	B->T	P->A	P->B	A->T	B->T	P->T
008	4	5	4	5	-	-	-	-	8
009	5	5	6	7	-	-	-	-	7

2

Flow curves

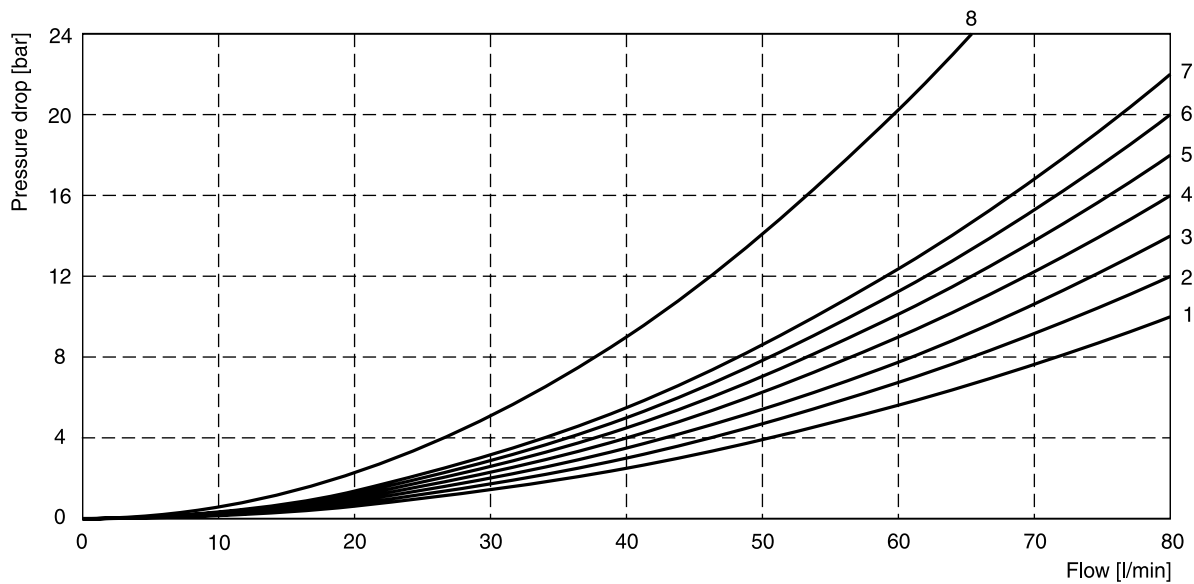

All characteristic curves measured with HLP46 at 50°C.

Shift limits

Spool	Shift limit [l/min]
001	60
002	
004	
006	
020	
030	
008	40
009	
026	20

The flow curve diagram shows the flow versus pressure drop curves for all spool types. The relevant curve

number for each spool type, operating position and flow direction is given in the table below.

Spool	Position „b“		Position „a“		Position „0“						
	P-A	B-T	P-B	A-T	P-A	P-B	A-T	B-T	P-T	A-B	
001	4	3	4	3	-	-	-	-	-	-	
002	2	4	3	3	2	2	1	2	3	4	
003	2	2	4	1	-	-	5	-	-	-	
004	4	3	3	2	-	-	5	5	-	6	
005	1	3	4	2	4	-	-	-	-	-	
006	2	4	3	3	5	5	-	-	-	6	
007	4	2	2	2	-	2	-	2	5	-	
010	2	-	2	-	-	-	-	-	-	-	
011	3	3	2	3	-	-	10	10	-	11	
014	2	3	4	2	2	-	2	-	5	-	
015	4	2	2	2	-	-	-	4	-	-	
016	4	2	1	1	-	4	-	-	-	-	
020	4	4	4	4	-	-	-	-	-	-	
026	3	-	3	-	-	-	-	-	-	-	
030	4	3	3	3	-	-	-	-	-	-	
081	6	7	6	7	-	-	-	-	-	-	
082	7	7	6	5	-	-	11	11	-	11	
101	9	9	9	9	-	-	-	-	-	-	
102	2	2	2	1	6	6	3	5	6	6	
	P-B	A-T	P-A	B-T	P-A	P-B	A-T	B-T	P-T	A-B	
008	4	2	5	6					8		
009	2	5	2	6	-	-	-	-	8	-	
	Position „b“		Position „a“		Position „0“						
	P-A	B-T	A-B	P-B	A-T		A-T				
021	3	5	6	4	2	-	-	-			
031	3	5	6	4	1	-	9	-			
	P-A	B-T		P-A	P-B	A-B		B-T			
022	5	4	-	5	2	6	-	-			
032	5	2	-	5	2	6	-	9			

2

Flow curves

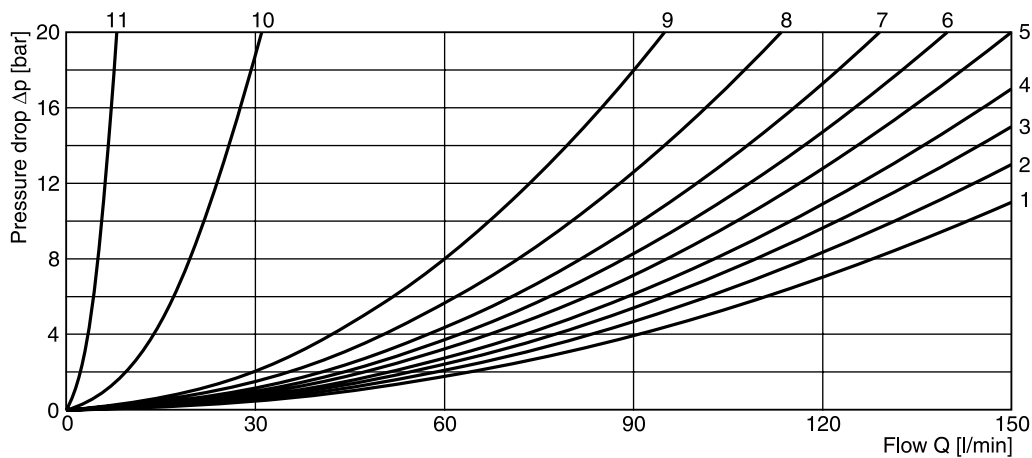

All characteristic curves measured with HLP46 at 50°C.

The flow curve diagram shows the flow versus pressure drop curves for all spool types. The relevant curve

number for each spool type, operating position and flow direction is given in the table below.

D4P

Spool Code	Curve number				
	P-A	P-B	P-T	A-T	B-T
001	1	1	-	4	5
002	1	2	6	4	6
003	1	2	-	5	6
004	1	1	-	5	5
005	2	2	-	3	5
006	1	2	-	3	6
007	1	1	6	4	5
009	2	9	8	7	10
011	1	1	-	4	5
014	1	1	6	4	5
015	1	2	-	4	6
016	2	2	-	3	5
020	3	5	-	3	5
021	2	8	-	2	-
022	8	2	-	-	3
026	3	5	-	-	-
030	2	3	-	6	7
054	2	3	-	6	7

D4P

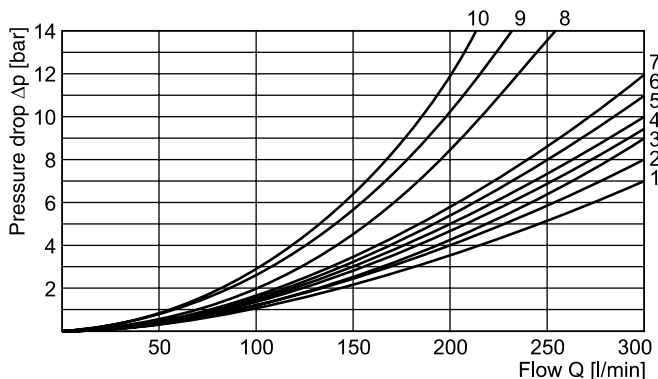

D9P and D11P

Spool Code	Curve number									
	P-A		P-B		P-T		A-T		B-T	
	D9	D11	D9	D11	D9	D11	D9	D11	D9	D11
001	3	5	2	5	-	-	3	4	5	1
002	2	5	1	5	1	5	3	4	5	1
003	4	-	2	-	-	-	3	-	6	-
004	4	5	3	5	-	-	3	4	5	1
005	1	-	2	-	-	-	4	-	5	-
006	2	-	2	-	-	-	4	-	6	-
007	3	-	1	-	7	-	3	-	5	-
009	4	3	8	3	9	2	4	3	10	1
011	3	-	2	-	-	-	3	-	5	-
014	1	-	2	-	8	-	3	-	5	-
015	3	-	3	-	-	-	4	-	5	-
016	3	-	3	-	-	-	4	-	5	-
020	6	5	5	5	-	-	6	3	8	1
021	5	-	10	-	-	-	3	-	-	-
022	10	-	5	-	-	-	-	-	5	-
026	6	-	5	-	-	-	-	-	-	-
030	3	5	2	5	-	-	3	4	5	1
054	-	5	-	5	-	-	-	4	-	1

D9P

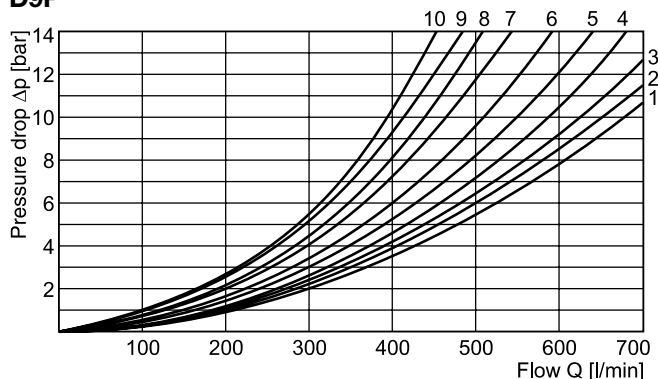

D11P

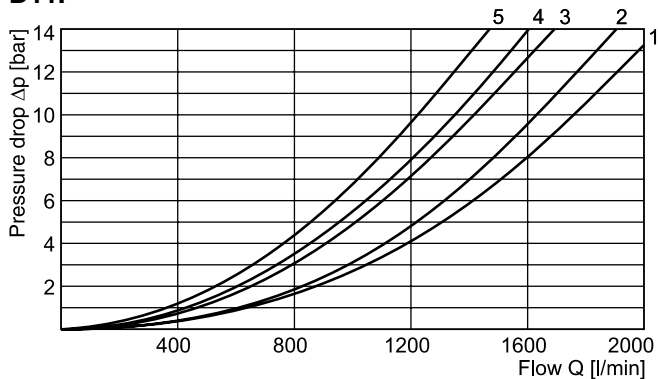



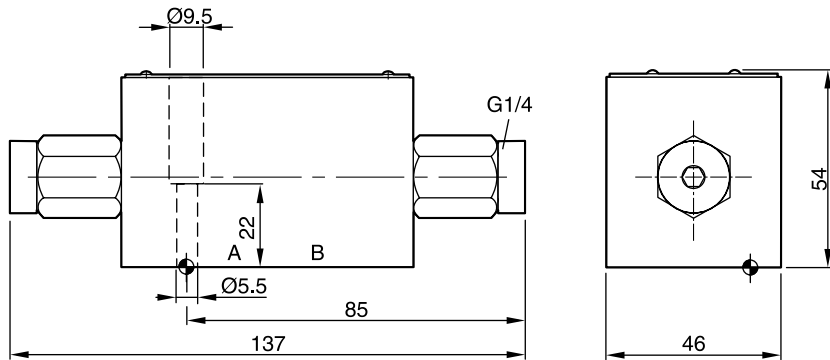

All characteristic curves measured with HLP46 at 50°C.

D1VP*90

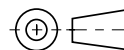



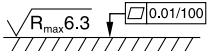

2

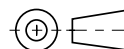
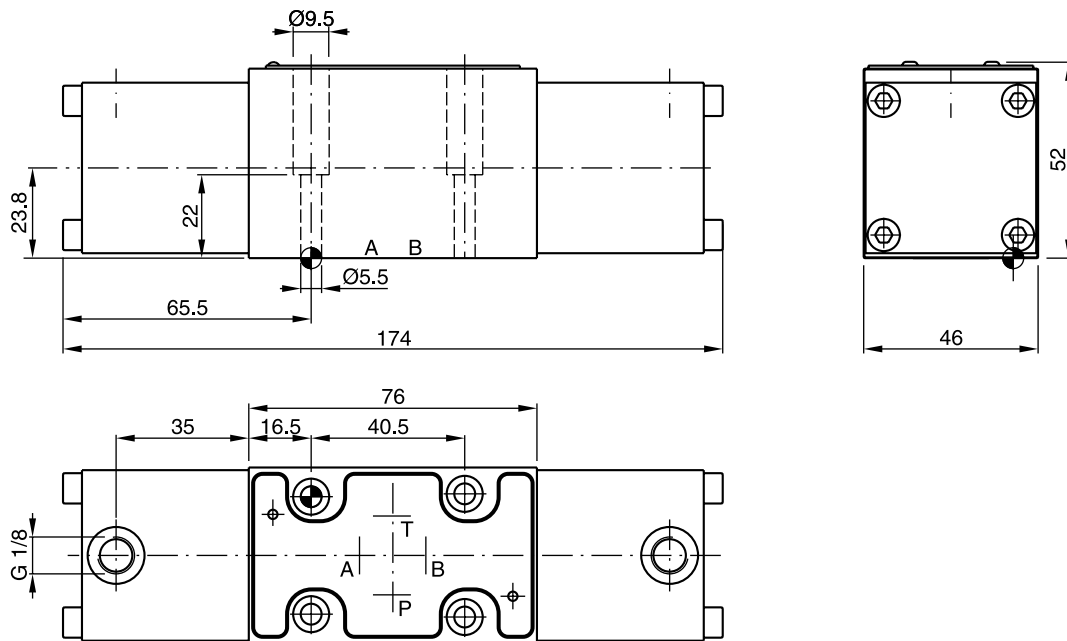

Surface finish	 Kit	 Kit	 Kit	 Kit
	BK375	4x M5x30 ISO 4762-12.9	7.6 Nm ±15 %	NBR: SK-D1VP-N-87 FPM: SK-D1VP-V-87

D1VP*4L



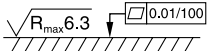



Surface finish	 Kit	 Kit	 Kit	 Kit
	BK375	4x M5x30 ISO 4762-12.9	7.6 Nm ±15 %	NBR: SK-D1VP-N4-91 FPM: SK-D1VP-V4-91

Dimensions

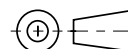
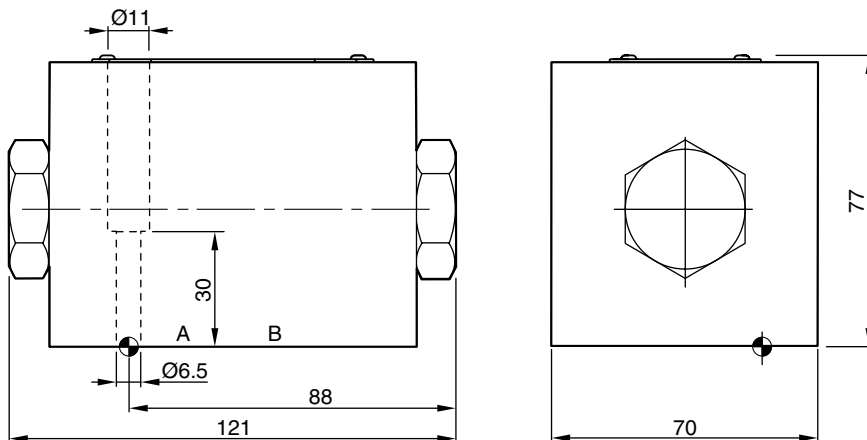
D3DP



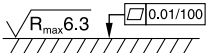

2

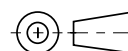
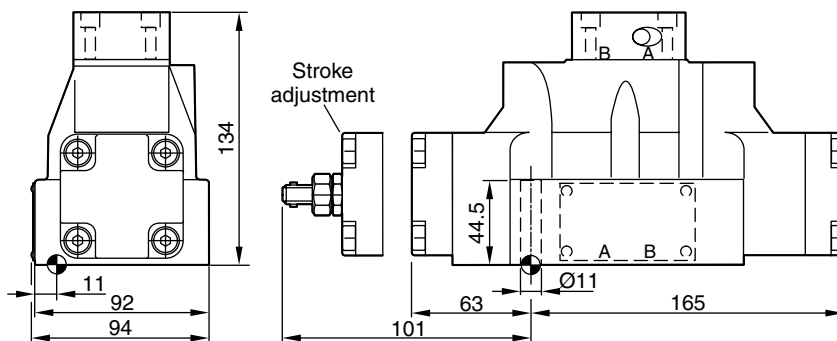

Surface finish	 Kit	 Kit	 Kit	 Kit
	BK385	4x M6x40 ISO 4762-12.9	13.2 Nm ±15 %	NBR: SK-D3DP-N-42 FPM: SK-D3DP-V-42

D4P

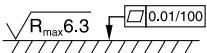

Surface finish	 Kit	 Kit	 Kit	 Kit
	BK320	4x M10x60 2 x M6x55 ISO 4762-12.9	63 Nm ±15 % 13.2 Nm ±15 %	NBR: SK-D41VW-N-91 FPM: SK-D41VW-V-91

D9P

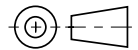
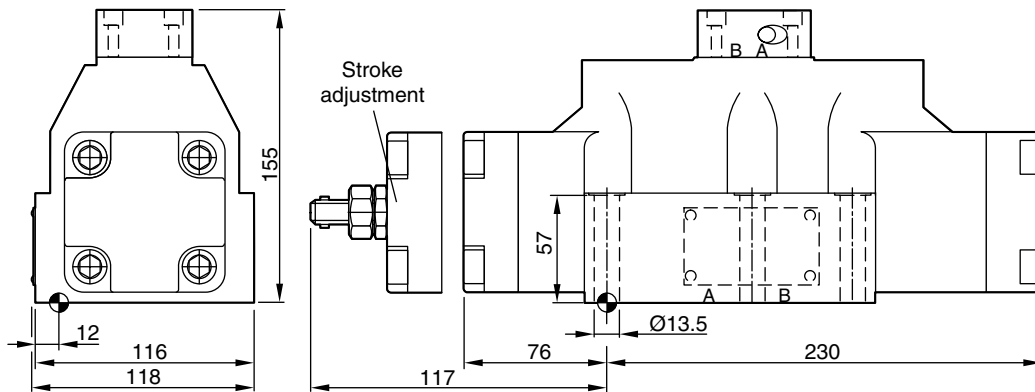

Surface finish	Kit	Kit	Kit	Kit
$\sqrt{R_{max}6.3}$ $\square 0.01/100$	BK360	6x M12x75 ISO 4762-12.9	108 Nm $\pm 15\%$	NBR: SK-D91VW-N-91 FPM: SK-D91VW-V-91

D11P

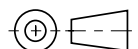
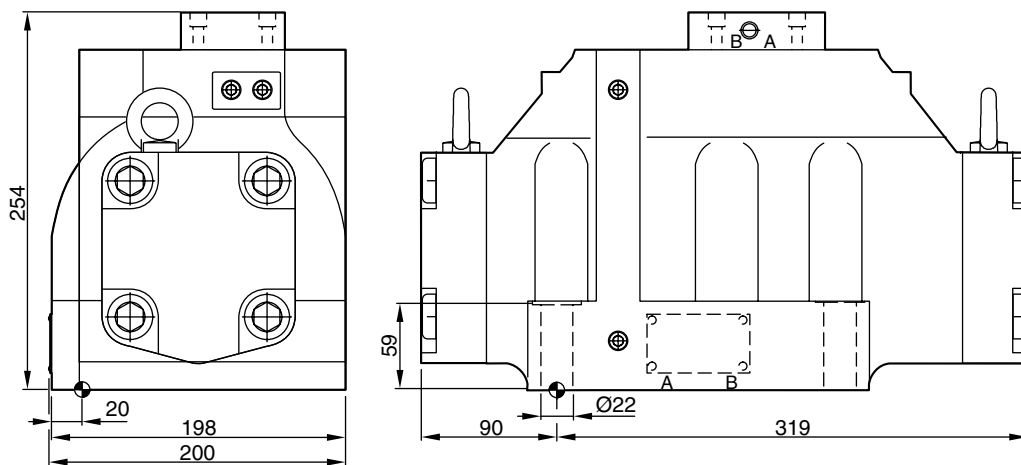

Surface finish	Kit	Kit	Kit	Kit
$\sqrt{R_{max}6.3}$ $\square 0.01/100$	BK386	6x M20x90 ISO 4762-12.9	517 Nm $\pm 15\%$	NBR: SK-D111VW-N-91 FPM: SK-D111VW-V-91