



aerospace
climate control
electromechanical
filtration
fluid & gas handling
hydraulics
pneumatics
process control
sealing & shielding



Pneumatic Cylinders

Ø32 to Ø125 mm

According to ISO 15552

Catalogue PDE3570TCEN



ENGINEERING YOUR SUCCESS.



Important

Before attempting any external or internal work on the cylinder or any connected components, make sure the cylinder is vented and disconnect the air supply in order to ensure isolation of the air supply.



Note

All technical data in this catalogue are typical data only.
Air quality is essential for maximum cylinder service life (see ISO 8573).



WARNING

FAILURE OR IMPROPER SELECTION OR IMPROPER USE OF THE PRODUCTS AND/OR SYSTEMS DESCRIBED HEREIN OR RELATED ITEMS CAN CAUSE DEATH, PERSONAL INJURY AND PROPERTY DAMAGE.

This document and other information from Parker Hannifin Corporation, its subsidiaries and authorized distributors provide product and/or system options for further investigation by users having technical expertise. It is important that you analyze all aspects of your application and review the information concerning the product or system in the current product catalog. Due to the variety of operating conditions and applications for these products or systems, the user, through its own analysis and testing, is solely responsible for making the final selection of the products and systems and assuring that all performance, safety and warning requirements of the application are met. The products described herein, including without limitation, product features, specifications, designs, availability and pricing, are subject to change by Parker Hannifin Corporation and its subsidiaries at any time without notice.

SALE CONDITIONS

The items described in this document are available for sale by Parker Hannifin Corporation, its subsidiaries or its authorized distributors. Any sale contract entered into by Parker will be governed by the provisions stated in Parker's standard terms and conditions of sale (copy available upon request).

Contents	Page
Product Overview	4 - 5
Cylinder Technical Data	6 - 7
Cylinder Size and Selection Guide	8 - 11
Cylinder Dimensions	12 - 15
Order Code Cylinder	16
Order Code Mountings	17
Mounting Dimensions	18 - 25
Sensors	26 - 29
Cylinder Seal Kits	30
Air Quality Specification	31

Standard Cylinders ISO 15552

Global product range

The P1F Series meets the specifications of the ISO 15552 standard. This means full interchangeability to any cylinder anywhere around the globe. P1F will be available throughout the extensive worldwide Parker Hannifin organisation – for the benefit to you and your customers.



Features

- Smooth profile or Tie-Rods design.
- Bore sizes 32 - 125 mm.
- Corrosion resistant design with end plates and barrel in sandblast and anodised aluminium.
- Stainless steel piston rod.
- Polyurethane seal technology inside.
- Cushioning stainless steel screws on same side.
- New adjustable pneumatic and mechanical cushioning system reduces the noise caused by the impact of the piston on the end covers.
- Full range of mountings available.
- Full range of 'drop-in' sensors available.

Design Variants

Smooth profile - P1F-S, P1F-K

The P1F in bore sizes Ø32 to Ø125 mm is a smooth profile designed cylinder with magnetic piston used for standard temperature -20°C to +80°C. Utilising internal composite technology to save weight, while assuring the high performance and functionality expected of an ISO cylinder. With aluminum sandblast front and rear end plates, PTFE coated steel bearing with stainless steel piston rod, pneumatic cushioning and magnetic piston with Polyurethane seals as standard this is our industrial profile ISO cylinder.



Smooth profile - P1F-A

Similar to the smooth profile version but in an ATEX variant and a restricted temperature range -20°C to +60°C. For applications in explosive atmosphere, like silos, oil and gas...



Tie-Rods round profile - P1F-T, P1F-N

Similar to the smooth profile version but in a Tie-Rods design for heavy duty applications. Round tube is made in anodised aluminium; Tie-Rods in stainless steel as a standard.



High temperature option

All seals in the high temperature version of P1F are developed and validated for continuous operation up to +150°C. The combination of the seal geometry and the FKM (fluoro elastomers) material ensures reliable and long service life. High temperature cylinders have no magnetic piston and cannot be fitted with sensors (the magnetic field strength in high temperatures is too low to ensure correct reliable sensor function). The key for reliable operation of pneumatic cylinders in high temperatures is the seal and grease system.

Metallic scraper option

In environments where the piston rod may be coated with resin, ice, cement, sugar crystals, dough, etc., primarily in timber handling, refrigerated/chilled transport, cement industry, chemicals and food and drinks a metal scraper in combination with a hard-chromium plated piston rod is the right decision in temperature ranges from -30°C to +80°C.

With rod locks - P1F-L, P1F-H

With an air/spring rod lock allowing the piston rod to be braked or locked in any position. Incorporating a powerful piston rod locking device, which clamps the piston rod and locks it in position in static, H version or in dynamic, L version. The locking device is a spring lock with an air pressure release and is integrated into the front plate of the cylinder. In the absence of an air signal pressure, full holding force is applied to the piston rod. Fully integrated in the front end cap for the L version, added as an accessories for the H version.

Air Reservoirs - P1F-P

The air reservoirs are produced by a cylinder tube and two standard rear end plates and used, e.g. together with throttle valves to achieve a timer function in a pneumatic system. The delay of time will be varied by changing the throttle valve and by the size of the air reservoir. With a well functioning throttle valve and a suitable air reservoir it would be possible to achieve an accuracy of $\pm 5\%$. The reservoir is also used to equal pressure variants into system and to handling short extreme air consumptions without functional disorders. The air reservoirs could also be used together with check valves in order to retain a pressure which is essential for safety reasons.

Low temperature option

All seals in the low temperature version of P1F are developed and validated for continuous operation down to -40°C. Polyurethane PUR seal technology and specifically formulated grease support performance and reliability for low temperature applications. As standard supplied with a magnetic ring in the piston for proximity sensing.

Seals engineered for low temperature in polyurethane formulated specifically for optimal performance in the temperature range -40°C to +80°C.

FKM scraper option

For use in applications where chemicals may affect the scraper in the front end cover, an option with a scraper in FKM (fluoro elastomers) for better chemical resistance must be used in temperature ranges from -10°C to +80°C.



Technical Data

Cylinder forces

Bore/piston rod [mm]	Stroke	Surface area [cm ²]	Max theoretical force in N in relation to applied pressure in bar									
			1	2	3	4	5	6	7	8	9	10
32/12	+	8.0	80	161	241	322	402	483	563	643	724	804
	-	6.9	69	138	207	276	346	415	484	553	622	691
40/16	+	12.6	126	251	377	503	628	754	880	1005	1131	1257
	-	10.6	106	211	317	422	528	633	739	844	950	1056
50/20	+	19.6	196	393	589	785	982	1178	1374	1571	1767	1964
	-	16.5	165	330	495	660	825	990	1155	1319	1484	1649
63/20	+	31.2	312	623	935	1247	1559	1870	2182	2494	2806	3117
	-	28.0	280	561	841	1121	1402	1682	1962	2242	2523	2803
80/25	+	50.3	503	1005	1508	2011	2513	3016	3519	4021	4524	5027
	-	45.4	454	907	1361	1814	2268	2721	3175	3629	4082	4536
100/25	+	78.5	785	1571	2356	3142	3927	4712	5498	6283	7069	7854
	-	73.6	736	1473	2209	2945	3682	4418	5154	5891	6627	7363
125/32	+	122.7	1227	2454	3682	4909	6136	7363	8590	9818	11045	12272
	-	114.7	1147	2294	3440	4587	5734	6881	8027	9174	10321	11468

+ = outward stroke
- = return stroke

Cylinder air consumption

Bore/piston rod [mm]	Stroke	Surface area [cm ²]	Air consumption in l/mm in relation to applied pressure in bar									
			1	2	3	4	5	6	7	8	9	10
32/12 (G1/8)	+	8.0	0.016	0.024	0.032	0.040	0.048	0.056	0.064	0.072	0.079	0.087
	-	6.9	0.014	0.021	0.027	0.034	0.041	0.048	0.055	0.061	0.068	0.075
40/16 (G1/4)	+	12.6	0.025	0.037	0.050	0.062	0.075	0.087	0.099	0.112	0.124	0.137
	-	10.6	0.021	0.031	0.042	0.052	0.063	0.073	0.083	0.094	0.104	0.115
50/20 (G1/4)	+	19.6	0.039	0.058	0.078	0.097	0.117	0.136	0.155	0.175	0.194	0.213
	-	16.5	0.033	0.049	0.065	0.082	0.098	0.114	0.130	0.147	0.163	0.179
63/20 (G3/8)	+	31.2	0.062	0.093	0.123	0.154	0.185	0.216	0.247	0.277	0.308	0.339
	-	28.0	0.056	0.083	0.111	0.139	0.166	0.194	0.222	0.249	0.277	0.305
80/25 (G3/8)	+	50.3	0.100	0.150	0.199	0.249	0.298	0.348	0.398	0.447	0.497	0.546
	-	45.4	0.090	0.135	0.180	0.224	0.269	0.314	0.359	0.404	0.448	0.493
100/25 (G1/2)	+	78.5	0.156	0.234	0.311	0.389	0.466	0.544	0.621	0.699	0.776	0.854
	-	73.6	0.146	0.219	0.292	0.364	0.437	0.510	0.582	0.655	0.728	0.800
125/32 (G1/2)	+	122.7	0.244	0.365	0.486	0.607	0.728	0.850	0.971	1.092	1.213	1.334
	-	114.7	0.228	0.341	0.454	0.567	0.681	0.794	0.907	1.020	1.134	1.247

+ extending, - retracting

free air consumption for 1 cycle, 10 mm inward and 10 mm outward

Weight

Cyl.-bore [mm]	P1F-S/A/L/H		P1F-T		Moving parts		Adder for rod lock	
	Base 0 mm [kg]	per 100 mm [kg]	Base 0 mm [kg]	per 100 mm [kg]	Base 0 mm [kg]	per 100 mm [kg]	P1F-H [kg]	P1F-L [kg]
Ø32	0.54	0.23	0.49	0.27	0.10	0.09	0.6	0.41
Ø40	0.74	0.32	0.73	0.31	0.19	0.16	0.8	0.44
Ø50	1.22	0.47	1.19	0.52	0.34	0.25	1.0	0.61
Ø63	1.69	0.49	1.68	0.54	0.40	0.24	1.2	1.25
Ø80	2.50	0.73	2.48	0.84	0.73	0.39	1.4	2.45
Ø100	3.65	0.80	3.66	0.88	1.02	0.38	1.6	3.72
Ø125	6.41	1.37	6.30	1.32	2.01	0.63	1.8	6.07

Technical Data

Product type	Standard cylinder according to ISO 15552
Bore size	32 - 125 mm
Stroke length	5 - 2000 mm
Versions	Double acting
Cushioning	Adjustable air cushioning
Position sensing	Proximity sensor
Installation	ISO cylinder and piston rod mountings



Operating and environmental data

Operating medium	For best possible service life and trouble-free operation dry filtered compressed air to ISO 8573-1:2010 quality 3.4.3 should be used. This specifies a dew point of + 3°C for indoor operation (a lower dew point should be selected for minus temperature operation and we recommend the use of an inline dryer) and is in line with the air quality from most standard compressors with a standard filter.		
Operating pressure	1 to 10 bar		
Ambient temperature	Standard temperature version: -20°C to +80°C	Metal scraper wiper seal:	-30°C to +80°C
	High temperature version: -10°C to +150°C	With FKM wiper seal:	-10°C to +80°C
	Low temperature version: -40°C to + 80°C		
Pre-lubricated	Further lubrication is normally not necessary. If additional lubrication is introduced it must be continued. Hydraulic oil type HLP (DIN 51524, ISO 11158). Viscosity by 40°C: 32 mm2/s (cst). Example: Shell Tellus 32 or equal.		
Corrosion resistance	Material and surface treatment selected for typical industrial applications with resistance to corrosion and chemicals.		

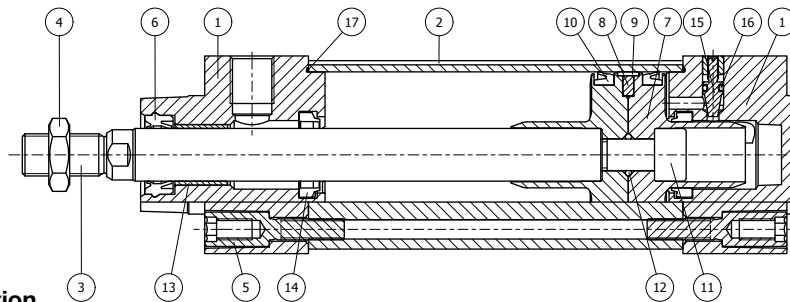

Material specification

Pos	Part		Specification
1	End covers		Aluminium
2	Cylinder barrel		Anodised aluminium (profile or round tube)
3	Piston rod	Standard	Austenitic stainless steel, DIN X8 CrNiS 18 - 9
		Optional	Chromium plated steel DIN C45E
			Chromium plated stainless steel DIN X2 CrNiMoN 17- 12 - 2
4	Piston rod nut	Standard	Zinc plated steel
		Optional	Stainless steel
5	End cover screws	Standard	Zinc plated steel
		Optional	Stainless steel
6	Piston rod seal	Standard	Polyurethane (TPU-PUR)
		Optional	Fluoro elastomer (FKM) / Metallic scraper (Brass)
7	Piston	Standard	Poloxymethylene (POM)
		Optional	Aluminium
8	Magnet		Plastic coated magnetic material
9	Piston bearing	Standard	Poloxymethylene (POM)
		Optional	Polytetrafluoroethylene (PTFE)
10	Piston seals	Standard	Polyurethane (TPU-PUR)
		Optional	Fluoro elastomer (FKM)
11	Piston bolt		Zinc plated steel
12	O-ring piston bolt	Standard	Nitrile rubber (NBR)
		Optional	Fluoro elastomer (FKM)
13	Piston rod bearing		Multilayer Steel / PTFE
14	Cushioning seals	Standard	Polyurethane (TPU-PUR)
		Optional	Fluoro elastomer (FKM)
15	Cushioning screw		Stainless steel DIN X8 CrNiS 18-9
16	O-ring cushioning screw	Standard	Nitrile rubber (NBR)
		Optional	Fluoro elastomer (FKM)
17	O-ring end cover	Standard	Nitrile rubber (NBR)
		Optional	Fluoro elastomer (FKM)
	Tie-Rods		Austenitic stainless steel, DIN X8 CrNiS 18-9
	Tie-Rods nut		Zinc plated steel

Guide for selecting suitable tubing

The selection of the correct size of tubing is often based on experience, with no great thought to optimising energy efficiency and cylinder velocity. This is usually acceptable, but making a rough calculation can result in worthwhile economic gains.

The following is the basic principle:

1. The primary line to the working valve could be oversized (this does not cause any extra air consumption and consequently does not create any extra costs in operation).
2. The tubes between the valve and the cylinder should, however, be optimised according to the principle that an insufficient bore throttles the flow and thus limits the cylinder speed, while an oversized pipe creates a dead volume which increases the air consumption and filling time.

The following prerequisites apply

The cylinder load should be about 50 % of the theoretical force (= normal load). A lower load gives a higher velocity and vice versa. The tube size is selected as a function of the cylinder bore, the desired cylinder velocity and the tube length between the valve and the cylinder. If you want to use the capacity of the valve to its maximum, and obtain maximum speed, the tubing should be chosen so that they at least correspond with the equivalent restriction diameter (see description below), so that the tubing does not restrict the total flow. This means that a short tubing must have at least the equivalent restriction diameter. If the tubing is longer, choose it from the table below. Straight fittings should be chosen highest flow rates. Rates as elbow and banjo fittings cause restriction.

The chart below is intended to help when selecting the correct size of tube to use between the valve and the cylinder.

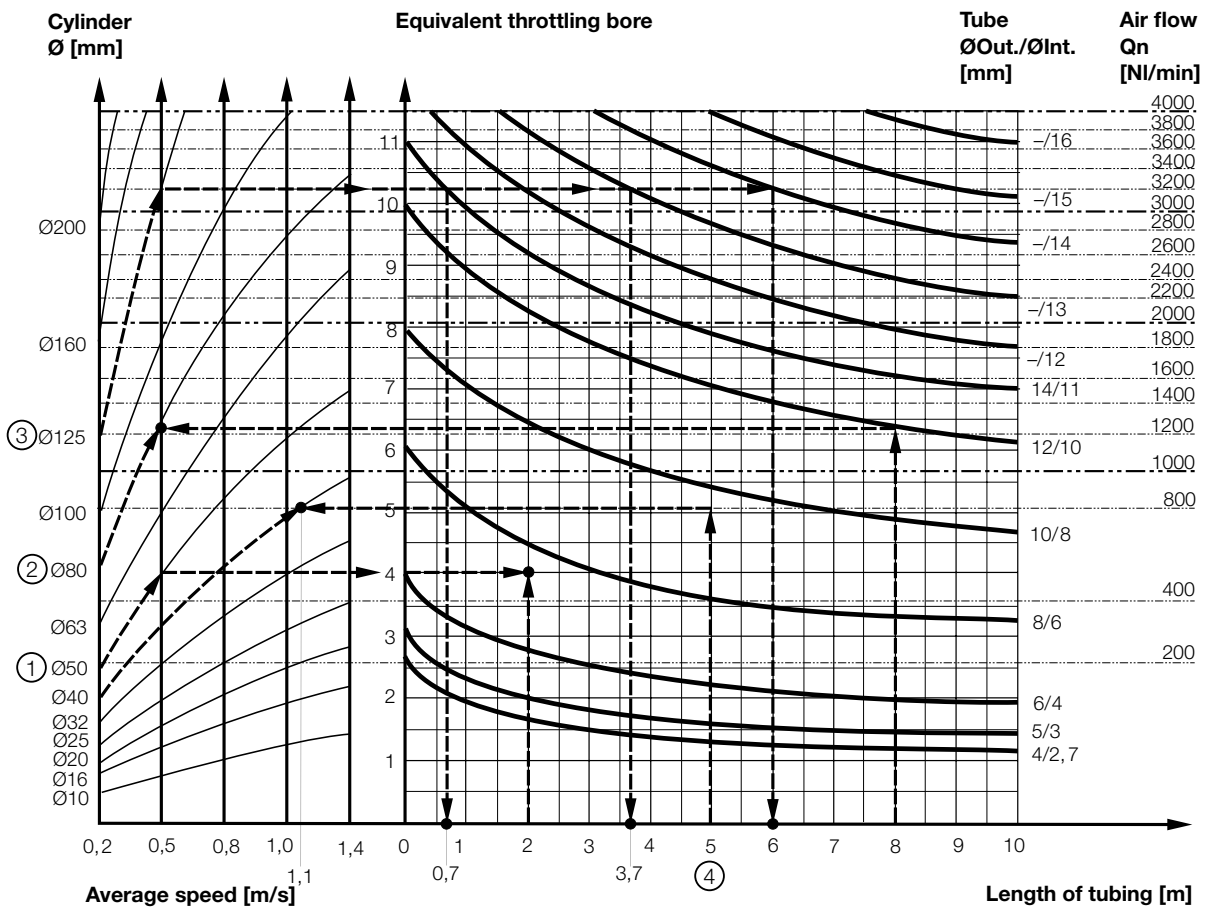

The equivalent throttling bore is a long throttle (for example a tube) or a series of throttles (for example, through a valve) converted to a short throttle which gives a corresponding flow rate. This should not be confused with the orifice which is sometimes specified for valves. The value for the orifice does not normally take account of the fact that the valve contains a number of throttles.

Qn is a measure of the valve flow capacity, with flow measured in liter per minute (l/min) at 6 bar(e) supply pressure and 1 bar pressure drop across the valve.

Example ①:
Which tube diameter should be used?

A 50 mm bore cylinder is to be operated at 0.5 m/s. The tube length between the valve and cylinder is 2 m. In the diagram we follow the line from 50 mm bore to 0.5 m/s and get an "equivalent throttling bore" of approximately 4 mm. We continue out to the right in the chart and intersect the line for a 2 m tube between the curves for 4 mm (6/4 tube) and 6 mm (8/6 tube). This means that a 6/4 tube throttles the velocity somewhat, while an 8/6 tube is a little too large. We select the 8/6 tube to obtain full cylinder velocity.

Example ②:
What cylinder velocity will be obtained?

A 80 mm bore cylinder will be used, connected by 8 m 12/10 tube to a valve with Qn 1200 NI/min. What cylinder velocity will we get? We refer to the diagram and follow the line from 8 m tube length up to the curve for 12/10 tube. From there, we go horizontally to the curve for the Ø80 cylinder. We find that the velocity will be about 0.5 m/s.

Example ③:
What is the minimum inner diameter and maximum length of tube?

For an application a 125 mm bore cylinder will be used. Maximum velocity of piston rod is 0.5 m/s. The cylinder will be controlled by a valve with Qn 3200 NI/min. What diameter of tube can be used and what is maximum length of tube. We refer to the diagram. We start at the left side of the diagram cylinder Ø125. We follow the line until the intersection with

the velocity line of 0.5 m/s. From here we draw a horizontal line in the diagram. This line shows us we need an equivalent throttling bore of approximately 10 mm. Following this line horizontally we cross a few intersections. These intersections shows us the minimum inner diameter (rightside diagram) in combination with the maximum length of tube (bottomside diagram).

For example:
 Intersection one: When a tube (14/11) will be used, the maximum length of tube is 0.7 meter.
 Intersection two: When a tube (—/13) will be used, the maximum length of tube is 3.7 meter.
 Intersection three: When a tube (—/14) will be used, the maximum length of tube is 6 meter.

Example ④: Determining tube size and cylinder velocity with a particular cylinder and valve?

For an application using a 40 mm bore cylinder with a valve with Qn=800 NI/min. The distance between the cylinder and valve has been set to 5 m.
 Tube dimension: What tube bore should be selected to obtain the maximum cylinder velocity? Start at pipe length 5 m, follow the line up to the intersection with 800 NI/min. Select the next largest tube diameter, in this case Ø10/8 mm.
 Cylinder velocity: What maximum cylinder velocity will be obtained? Follow the line for 800 NI/min to the left until it intersects with the line for the Ø40 mm cylinder. In this example, the speed is just above 1.1 m/s.

Cushioning Characteristics

Air cushion is used to absorb kinetic energy due to load and speed at both end of stroke. This typically consists of a threaded needle screw that adjusts into an orifice in the cylinder end plate. By adjusting the screw further into the orifice you lessen the amount of air that can escape in a given time. Slowing the exhaust of air creates back pressure which slows the piston as it enters into the end cushioning seal.

The mass is the sum of internal and external friction, plus any gravitational forces. Work out your expected moving mass and read off the maximum permissible speed at start of cushioning. Alternatively, take your desired speed and expected mass and find the cylinder bore size required. Please note that piston speed at start of cushioning is typically approx. 50 % higher than the average speed and that it is this higher speed which determines the choice of cylinder.

The graph is valid for an horizontal movement and the pressure of 6 bar.

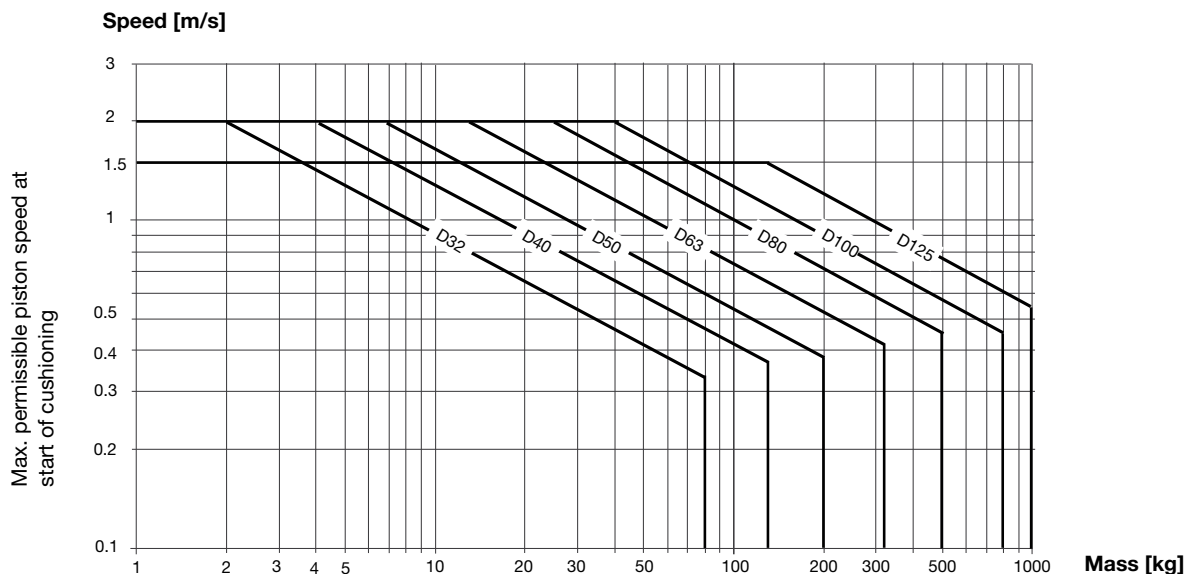

Cylinder with Rod Lock

Function on pressure loss

The piston rod lock can be used in all material handling systems where controlled fastening or positioning is required. Additional measures are required for use in safety-related applications (refer to EC Machinery Directive).

The piston rod cylinder with brakes is suitable for use in safety-related sections of control systems. The piston rod lock is also suitable for use as a pressure-loss brake for cylinders with suspended loads, for example. Piston rod can be held in position for long periods even with alternating loads, fluctuating operating pressure or leaks in the system. The signal air to the lock unit can be connected directly to the air system or to the supply air for the valve controlling the cylinder in question. For controlled on/off operation of the lock unit, a separate valve, with large exhaust flow capacity, is used.

Clean and compact design

The front end piece and lock unit form an integrated block, keeping the length of the structure short. The design is easy to clean, sealed and waterproof. The exhaust air from the lock unit can be removed by replacing the filter unit with a connector and hose. This is an advantage in terms of cleaning or when environmental factors are important.

Material specification, piston rod locking

	Dynamic Rod Lock Unit	Static Rod Lock Unit
Housing	Anodised aluminium	Anodised aluminium
Carriage	-	Anodised aluminium
Lock collars	Hardened steel	Brass
Springs	Stainless steel	Stainless steel
Bore sizes 32-40 mm	UHMWPE plastic	-
Bore sizes 50-125 mm	Polyurethane PUR	-
O Rings	Nitrile rubber NBR	-
Scraper ring	Polyurethane PUR	Polyurethane PUR
Air filter	Brass / Sintered bronze	-

Note!

If a rod guidance module is to be fitted to the brake and the cylinder, as the piston rod extension (WH dimension) is not in accordance with the ISO standard, the piston rod must be extended to provide the same WH dimension as for the cylinder itself.

Cylinder piston rod material must be made in steel or stainless steel chromium plated.

Technical data

Working pressure:	Max 10 bar	Max 10 bar
Working media:	Dry filtered compressed air	Dry filtered compressed air
Working temperature:	-20 to +80°C	-20 to +80°C
Release pressure ¹⁾ :	Min 4 bar +/- 10%	> 4 bar

¹⁾ Signal pressure to inlet port of lock unit

Static lock forces

Cylinder bore [mm]	Lock force [N] dyn. rod lock	Lock force [N] static rod lock
Ø32	550	600
Ø40	860	1000
Ø50	1345	1500
Ø63	2140	2200
Ø80	3450	3000
Ø100	5390	5000
Ø125	8425	7500

Locking and breaking

The static locking force corresponds to 7 bar pressure. Under certain circumstances, the lock can also be used as a brake for positioning or similar applications. The maximum values set out in the graph must not be exceeded.

Use as a brake

The table shows the maximum values for speed and braking mass if the cylinder is used as a brake. The cylinder should not be exposed to additional compressive forces as this significantly reduces the external mass that can be braked. The cylinder does not act as a motor during braking. Heat is generated if the brake is used frequently, and this must be taken into account too.

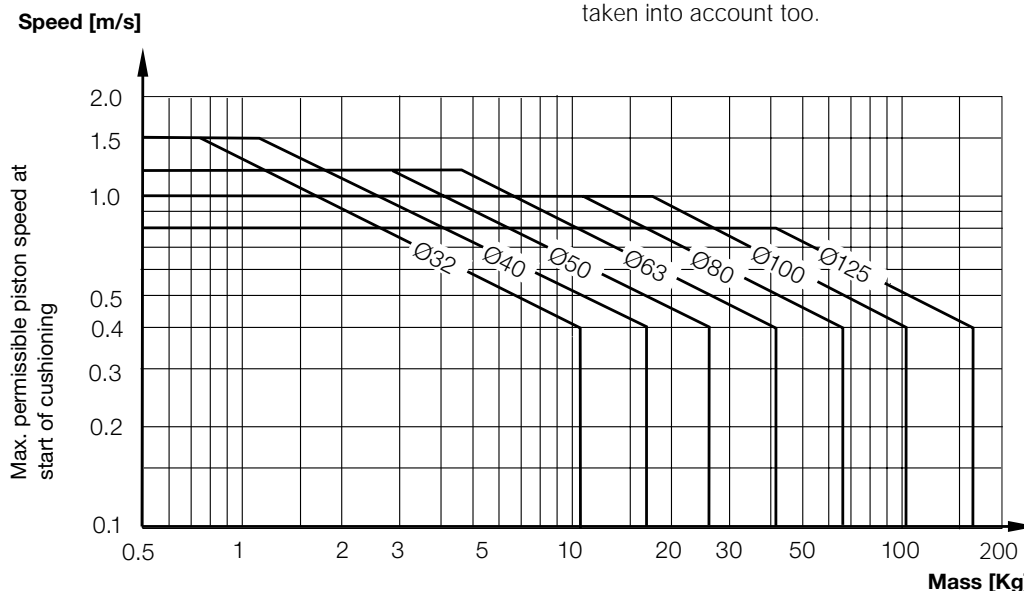

Cushioning Characteristics

Air cushion is used to absorb kinetic energy due to load and speed at both end of stroke. This typically consists of a threaded needle screw that adjusts into an orifice in the cylinder end plate. By adjusting the screw further into the orifice you lessen the amount of air that can escape in a given time. Slowing the exhaust of air creates back pressure which slows the piston as it enters into the end cushioning seal.

The mass is the sum of internal and external friction, plus any gravitational forces. Work out your expected moving mass and read off the maximum permissible speed at start of cushioning. Alternatively, take your desired speed and expected mass and find the cylinder bore size required. Please note that piston speed at start of cushioning is typically approx. 50 % higher than the average speed and that it is this higher speed which determines the choice of cylinder.

The graph is valid for an horizontal movement and the pressure of 6 bar.

Separate Rod Locking Device

Separate Rod Locking to be mounted on a standard P1F. The cylinder needs to have extended piston rod. Note! Chromium plated piston rod must be used.

Cyl.-bore [mm]	Rod [mm]	Rod extension [mm]	Weight [kg]	Order Code
Ø32	12	48	0.60	KC8227
Ø40	16	55	0.80	KC8228
Ø50	20	70	1.00	KC8229
Ø63	20	70	1.20	KC8230
Ø80	25	90	1.40	KC8231
Ø100	25	92	1.60	KC8232
Ø125	32	122	1.80	KC8233



Dimensions

Smooth profile design

P1F-S / P1F-A

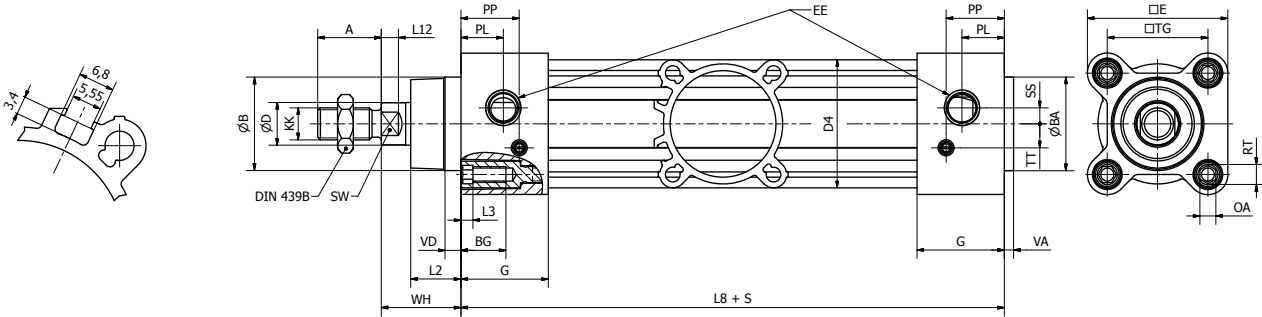

P1F-K

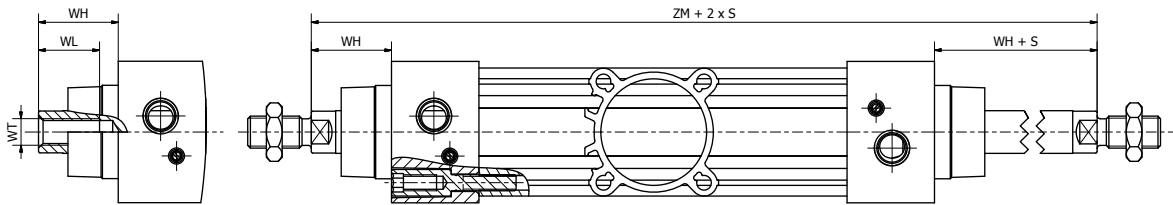

Tie-Rods with round profile design

P1F-T

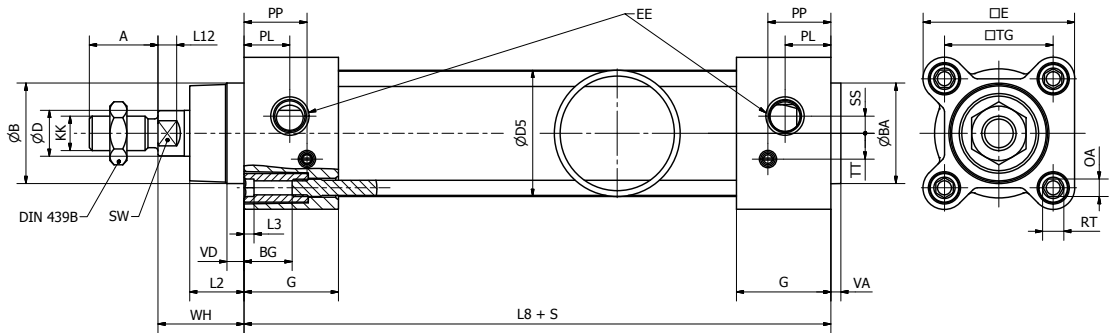

P1F-N

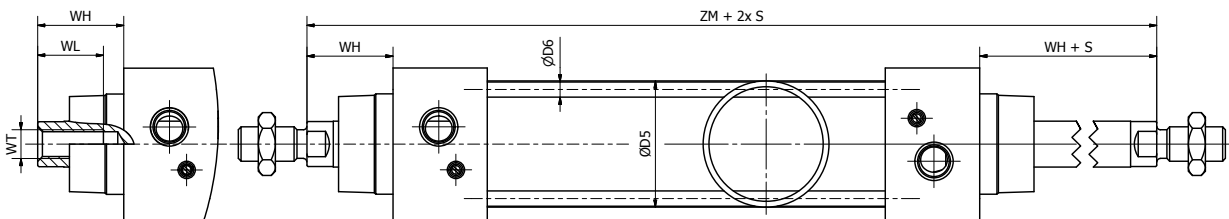

Dimensions

Dimensions [mm]

Cyl.-bore [mm]	A	ØB d11	ØBA d11	BG	ØD	D4	ØD5	ØD6	E	EE	G	KK	L2	L3	L8
Ø32	22	30	30	17	12	42.5	35	5.3	47	G1/8	28.4	M10x1.25	16.8	4.5	94
Ø40	24	35	35	17	16	48	43	5.3	53	G1/4	33	M12x1.25	19	4.5	105
Ø50	32	40	40	18	20	59.5	54	7.1	64.5	G1/4	33.4	M16x1.5	27.6	4.5	106
Ø63	32	45	45	18	20	69.5	67	7.1	75	G3/8	39.4	M16x1.5	24.3	4.5	121
Ø80	40	45	45	19.5	25	86	85	8.9	94	G3/8	39.4	M20x1.5	30.1	5.5	128
Ø100	40	55	55	19.5	25	103	105	8.9	111	G1/2	44.3	M20x1.5	34	5.5	138
Ø125	54	60	60	20	32	130	130	10.8	136	G1/2	50.8	M27x2	45	0	160

Cyl.-bore [mm]	L12	OA	PL	PP	RT	SS	SW	TG	TT	VA	VD	WH	WL	WT	ZM
Ø32	6	6	14	20	M6	5	10	32.5	6.5	3.6	6	26	21	M8x1	146
Ø40	6.5	6	16	22	M6	6	13	38	9	3.5	6	30	23	M10x1.25	165
Ø50	8	8	15.5	21.5	M8	6	17	46.5	9	3.6	6	37	31	M14x1.5	180
Ø63	8	8	18	28	M8	10	17	56.5	11	3.5	6	37	31	M14x1.5	195
Ø80	10	10	20	30	M10	11.5	22	72	14	3.5	6	46	39	M18x1.5	220
Ø100	10	10	18	33	M10	11.5	22	89	14	3.5	6	51	39	M18x1.5	240
Ø125	13	8	20	40	M12	0	27	110	22	5.5	9	65	53	M24x2	290

Tolerances [mm]

Cyl.-bore [mm]	A	L8	TG	ZM	stroke tolerance		
					s ≤ 350 mm	350 mm < s ≤ 600 mm	s > 600 mm
Ø32	0 / - 0.5	± 0.3	± 0.4	-0.4 / + 2.2	+ 1.7	+ 1.9	+ 2.3
Ø40	0 / - 0.5	± 0.3	± 0.4	-0.4 / + 2.2	+ 1.7	+ 1.9	+ 2.3
Ø50	0 / - 0.5	± 0.4	± 0.4	-0.4 / + 2.2	+ 1.8	+ 2	+ 2.4
Ø63	0 / - 0.5	- 0.5 / + 0.3	± 0.4	-0.4 / + 2.2	+ 1.9	+ 2.1	+ 2.5
Ø80	0 / - 0.5	± 0.4	± 0.4	-0.4 / + 2.2	+ 1.9	+ 2.1	+ 2.5
Ø100	0 / - 0.5	± 0.5	± 0.4	-0 / + 2.5	+ 2.0	+ 2.2	+ 2.6
Ø125	0 / - 1.0	± 0.5	± 0.4	-0 / + 2.6	+ 2.1	+ 2.3	+ 2.7

Dimensions

Dynamic rod lock with smooth profile design

P1F-L

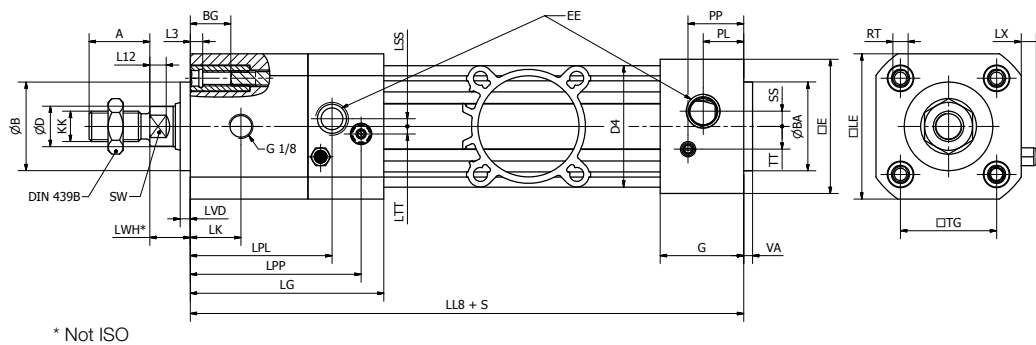

Static rod lock with smooth profile design

P1F-H

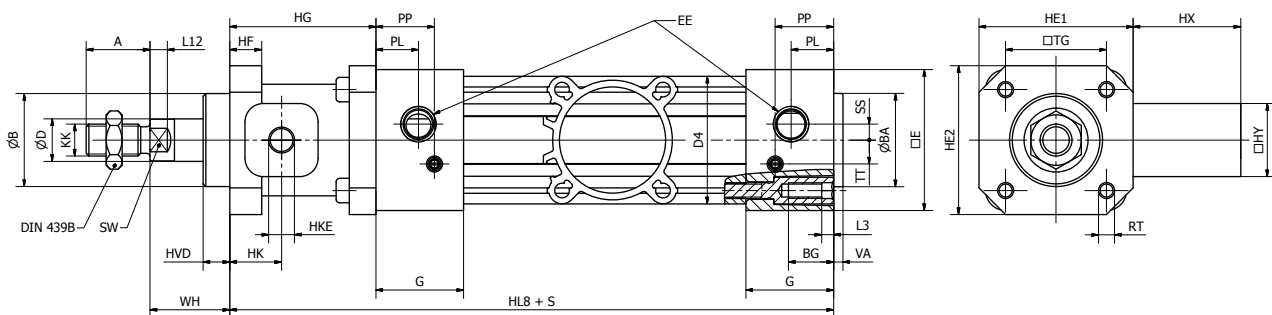

Air reservoir with smooth profile design

P1F-P

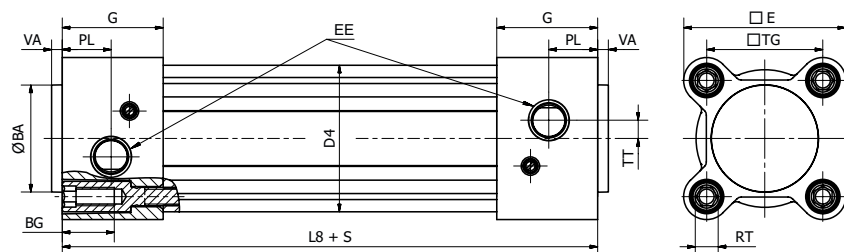

Important

Pressure Equipment Directive. According (PED) to the directive 2014/68/EU, for uncertified pressure vessels:

Max Working pressure x Volume maximized to 50 Bar x litre, i.e. max 10 bar and 5 liter volume.

In accordance we therefore maximised the volume to max 5 litre cylinder.

Dimensions

Dimensions [mm]

Cyl.-bore [mm]	A	ØB d11	ØBA d11	BG	ØD	D4	ØD5	ØD6	E	EE	G	KK	L2	L3	L8
Ø32	22	30	30	17	12	42.5	35	5.3	47	G1/8	28.4	M10x1.25	16.8	4.5	94
Ø40	24	35	35	17	16	48	43	5.3	53	G1/4	33	M12x1.25	19	4.5	105
Ø50	32	40	40	18	20	59.5	54	7.1	64.5	G1/4	33.4	M16x1.5	27.6	4.5	106
Ø63	32	45	45	18	20	69.5	67	7.1	75	G3/8	39.4	M16x1.5	24.3	4.5	121
Ø80	40	45	45	19.5	25	86	85	8.9	94	G3/8	39.4	M20x1.5	30.1	5.5	128
Ø100	40	55	55	19.5	25	103	105	8.9	111	G1/2	44.3	M20x1.5	34	5.5	138
Ø125	54	60	60	20	32	130	130	10.8	136	G1/2	50.8	M27x2	45	0	160

Cyl.-bore [mm]	L12	OA	PL	PP	RT	SS	SW	TG	TT	VA	VD	WH	WL	WT	ZM
Ø32	6	6	14	20	M6	5	10	32.5	6.5	3.6	6	26	21	M8x1	146
Ø40	6.5	6	16	22	M6	6	13	38	9	3.5	6	30	23	M10x1.25	165
Ø50	8	8	15.5	21.5	M8	6	17	46.5	9	3.6	6	37	31	M14x1.5	180
Ø63	8	8	18	28	M8	10	17	56.5	11	3.5	6	37	31	M14x1.5	195
Ø80	10	10	20	30	M10	11.5	22	72	14	3.5	6	46	39	M18x1.5	220
Ø100	10	10	18	33	M10	11.5	22	89	14	3.5	6	51	39	M18x1.5	240
Ø125	13	8	20	40	M12	0	27	110	22	5.5	9	65	53	M24x2	290

Cyl.-bore [mm]	LE	LG	LK	LL8	LPL	LPP	LSS	LTT	LVD	LWH	LX
Ø32	50	71	18.5	137	53	63	3	4.5	4	15	6
Ø40	57.4	76.5	20	149	56	67.5	3	3	4	16	6
Ø50	70	80	21	153	65	71	8	5.5	4	17	7
Ø63	82.4	96	30	178	76.5	87	8.5	3	4	17	7
Ø80	100	110	35	199	89	101	9	6	4	20	7
Ø100	116	132	54	226	112	122	12	6	4	20	7
Ø125	139	144.5	65.5	254	124.5	134.5	14	6	6	27	7

Cyl.-bore [mm]	HE1	HE2	HF	HG	HK	HKE	HL8	HVD	HX	HY
Ø32	50	48	12	48	16	G1/8	142	10	40	25
Ø40	58	56	12	55	19.5	G1/8	160	10	40.5	27.5
Ø50	70	68	16	70	21	G1/8	176	12	48.5	32.5
Ø63	85	82	15	70	21	G1/8	191	12	49	41
Ø80	105	100	16	90	28	G1/8	218	20	65.5	49
Ø100	130	120	18	92	27	G1/8	230	23	59.5	53
Ø125	150	140	27	122	37	G1/8	282	32	69.5	65

Tolerances [mm]

Cyl.-bore [mm]	A	L8	TG	ZM	stroke tolerance			P1F-P		
					350 mm < s			Cyl.-bore [mm]	Air volume [cm ³]	Air volume per stroke [cm ³ /100 mm]
					s ≤ 350 mm	≤ 600 mm	s > 600 mm			
Ø32	0/-0.5	± 0.3	±0.4	-0.4/+2.2	+ 1.7	+ 1.9	+ 2.3	Ø32	40	80
Ø40	0/-0.5	± 0.3	±0.4	-0.4/+2.2	+ 1.7	+ 1.9	+ 2.3	Ø40	68	126
Ø50	0/-0.5	- 0.3 / + 0.5	±0.4	-0.4/+2.2	+ 1.8	+ 2	+ 2.4	Ø50	91	196
Ø63	0/-0.5	- 0.6 / + 0.2	±0.4	-0.4/+2.2	+ 1.9	+ 2.1	+ 2.5	Ø63	137	312
Ø80	0/-0.5	± 0.4	±0.4	-0.4/+2.2	+ 1.9	+ 2.1	+ 2.5	Ø80	289	503
Ø100	0/-0.5	± 0.5	±0.4	-0/+2.5	+ 2.0	+ 2.2	+ 2.6	Ø100	417	785
Ø125	0/-1.0	± 0.5	±0.4	-0/+2.6	+ 2.1	+ 2.3	+ 2.7	Ø125	809	1227

Order code

Order Instructions P 1 F - S 0 3 2 M S - 0 1 6 0 - 0 0 0 0

Product family	
P1F	Rod type cylinder ISO15552

Air port design	
-	BSPP

Profile/cylinder design	
S	Smooth
A¹⁾	ATEX smooth
K	Smooth with through rod
L²⁾	Smooth with dynamic rod lock
H²⁾	Smooth with static rod lock
T	Tie-Rods
N	Tie-Rods with through rod
P	Air reservoir

Cylinder bore size	
032	32 mm
040	40 mm
050	50 mm
063	63 mm
080	80 mm
100	100 mm
125	125 mm

Rod extension or trunnion mounting	
0000	without
P . . .	Piston rod extension in mm
G000	Trunnion mount +90° vs. air ports
7000	Trunnion mount +0° vs. air ports

Cylinder Stroke	
....	Stroke length in mm (max. 2000)

Piston style	
-	Standard with magnet
F	Standard w/o magnet
X	Aluminium with magnet
A	Aluminium w/o magnet

Piston Rod material male thread	
S	Stainless steel
C	Chrome plated carbon steel
R	Chrome plated stainless steel***
A	without (air reservoir)

Piston Rod material female thread	
E	Stainless steel
F	Chrome plated carbon steel
G	Chrome plated stainless steel***

Temperature range	
Standard temp. -20 to +80°C	
M	Polyurethane (PUR)
V	FKM wiper seal -10° to +80°C
High Temp. -10 to +150°C	
F³⁾	Fluoro elastomere (FKM)
Low Temp. -40 to +80°C	
L³⁾	Polyurethane (TPU-PUR)
Q^{3) 4)}	Metallic scraper -30° to +80°C

*** on request

- ¹⁾ ATEX version is specified for standard temperature range -20°C to +60°C without options
- ²⁾ use the rod lock cylinder in standard temperature range -20°C to +80°C only in combination with chrome plated piston rod material
- ³⁾ High and low temp option only with aluminium piston
- ⁴⁾ Only in combination with chrome plated piston rod material

Standard strokes for all P1F cylinders compliant to ISO 4393
 (with the exception of stroke 40 mm)
 Special strokes up to 2000 mm.

Order code **Cylinder bore** ● = Standard stroke (mm) █ = Stroke to special order
 (mm) 0025 0040 0050 0080 0100 0125 0160 0200 0250 0320 0400 0500 0600 0700 0800 2000

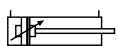

- P1F-S032MS -
- P1F-S040MS -
- P1F-S050MS -
- P1F-S063MS -
- P1F-S080MS -
- P1F-S100MS -
- P1F-S125MS -

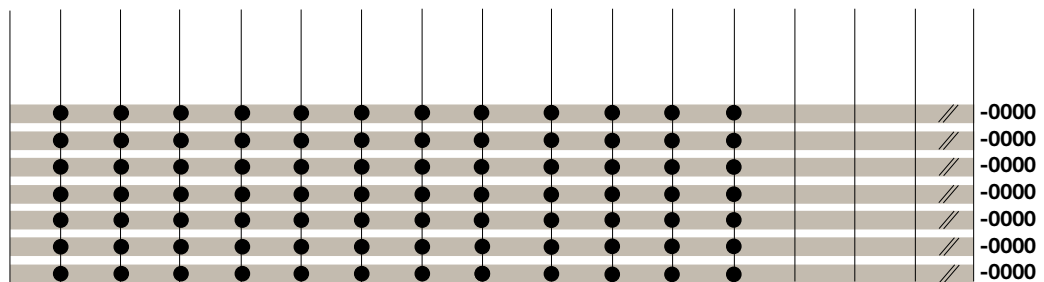

Mountings

Flange MF1 / MF2 ①



Foot brackets MS1 ②



Pivot bracket with rigid bearing AB7 ③



Swivel eye bracket MP6 ④



Clevis bracket MP2 ⑤



Ø32	P1C-4KMB	P1C-4KMF	P1C-4KMDB	P1C-4KMSB	P1C-4KMTB
Ø40	P1C-4LMB	P1C-4LMF	P1C-4LMDB	P1C-4LMSB	P1C-4LMTB
Ø50	P1C-4MMB	P1C-4MMF	P1C-4MMDB	P1C-4MMSB	P1C-4MMTB
Ø63	P1C-4NMB	P1C-4NMF	P1C-4NMDB	P1C-4NMSB	P1C-4NMTB
Ø80	P1C-4PMB	P1C-4PMF	P1C-4PMDB	P1C-4PMSB	P1C-4PMTB
Ø100	P1C-4QMB	P1C-4QMF	P1C-4QMDB	P1C-4QMSB	P1C-4QMTB
Ø125	P1C-4RMB	P1C-4RMF	P1C-4RMDB	P1C-4RMSB	P1C-4RMTB

Clevis bracket MP4 ⑥



Clevis bracket AB6 ⑦



Pivot bracket with swivel bearing CS7 ⑧



3 and 4 position flange JP1 ⑨



Pivot brackets AT4 ⑩



Ø32	P1C-4KMEB	P1C-4KMCB	P1C-4KMAF	P1E-6KB0	9301054261
Ø40	P1C-4LMEB	P1C-4LMCB	P1C-4LMAF	P1E-6LB0	9301054262
Ø50	P1C-4MMEB	P1C-4MMCB	P1C-4MMAF	P1E-6MB0	9301054262
Ø63	P1C-4NMEB	P1C-4NMCB	P1C-4NMAF	P1E-6NB0	9301054264
Ø80	P1C-4PMEB	P1C-4PMCB	P1C-4PMAF	P1E-6PB0	9301054264
Ø100	P1C-4QMEB	P1C-4QMCB	P1C-4QMAF	P1E-6QB0	9301054266
Ø125	P1C-4RMEB	P1C-4RMCB	P1C-4RMAF		9301054266

Flange trunnion MT5/MT6 ⑪



Intermediate trunnion MT4 ⑫



Swivel rod eye AP6 ⑬



Clevis AP2 ⑭



Flexo coupling PM5 ⑮



Ø32	P1D-4KMYF	Factory fitted	P1C-4KRS	P1C-4KRC	P1C-4KRF
Ø40	P1D-4LMYF	Factory fitted	P1C-4LRS	P1C-4LRC	P1C-4LRF
Ø50	P1D-4MMYF	Factory fitted	P1C-4MRS	P1C-4MRC	P1C-4MRF
Ø63	P1D-4NMYF	Factory fitted	P1C-4MRS	P1C-4MRC	P1C-4MRF
Ø80	P1D-4PMYF	Factory fitted	P1C-4PRS	P1C-4PRC	P1C-4PRF
Ø100	P1D-4QMYF	Factory fitted	P1C-4PRS	P1C-4PRC	P1C-4PRF
Ø125		Factory fitted	P1C-4RRS	P1C-4RRC	P1C-4RRF

Nut MR9 (pack of 10) ⑯

Zinc plated steel



Stainless steel



Ø32	P14-4KRPZ	P14-4KRPS
Ø40	P14-4LRPZ	P14-4LRPS
Ø50	P14-4MRPZ	P14-4MRPS
Ø63	P14-4MRPZ	P14-4MRPS
Ø80	P14-4PRPZ	P14-4PRPS
Ø100	P14-4PRPZ	P14-4PRPS
Ø125	P14-4RRPZ	P14-4RRPS

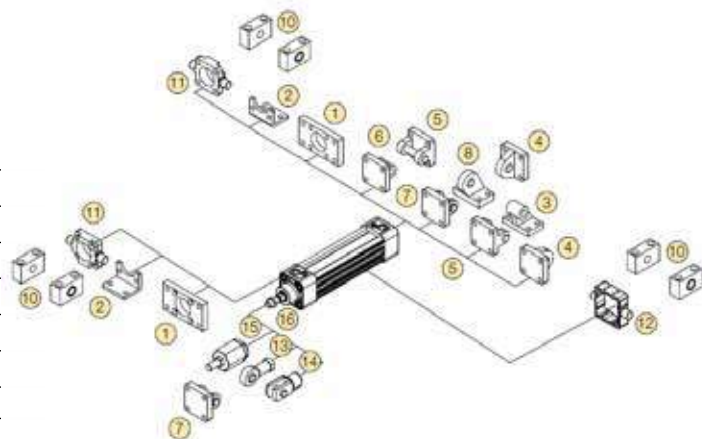

Flange - MF1 / MF2



Intended for fixed mounting of cylinder. Flange can be fitted to front or rear end cover of cylinder.

Materials:

Flange: Surface-treated steel
 Mounting screws acc. to DIN 6912:
 Zinc-plated steel 8.8
 Supplied complete with mounting screws for attachment to the cylinder.

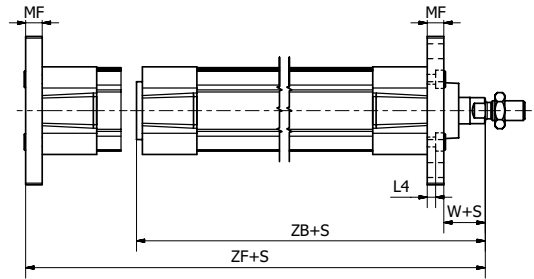
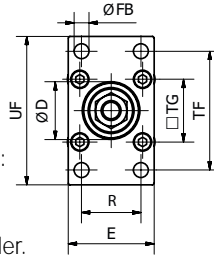

According to ISO 15552

Cyl.-bore	D _(H11)	E	ØFB _(H13)	L4	MF	R	TF	TG	UF	W*	ZB*	ZF*	Weight	Order code
[mm]	[mm]	[mm]	[mm]	[mm]	[mm]	[mm]	[mm]	[mm]	[mm]	[mm]	[mm]	[mm]	[kg]	
Ø32	30	45	7	5.0	10	32	64	32.5	80	16	123.5	130	0.21	P1C-4KMB
Ø40	35	52	9	5.0	10	36	72	38.0	90	20	138.5	145	0.27	P1C-4LMB
Ø50	40	65	9	6.5	12	45	90	46.5	110	25	146.5	155	0.53	P1C-4MMB
Ø63	45	75	9	6.5	12	50	100	56.5	120	25	161.5	170	0.66	P1C-4NMB
Ø80	45	95	12	9.0	16	63	126	72.0	150	30	177.5	190	1.45	P1C-4PMB
Ø100	55	115	14	9.0	16	75	150	89.0	170	35	192.5	205	1.60	P1C-4QMB
Ø125	60	140	16	10.5	20	90	180	110.0	205	45	230.5	245	3.34	P1C-4RMB

*Does not apply to cylinders with piston rod extension or lock units.

Foot Bracket - MS1



Intended for fixed mounting of cylinder. Foot bracket can be fitted to front or rear end cover of the cylinder.

Materials:

Flange: Surface-treated steel
 Mounting screws acc. to DIN 6912:
 Zinc-plated steel 8.8:

Supplied complete with mounting screws for attachment to the cylinder.

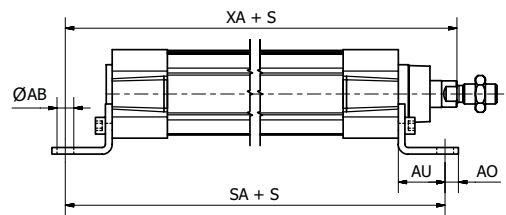
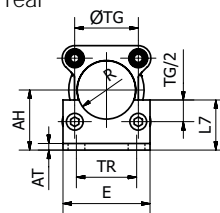

According to ISO 15552

Cyl.-bore	ØAB _(H14)	AH _(JS15)	AO	AT	AU	E	L7	R	SA*	TG	TR _(JS14)	XA*	Weight **	Order code
[mm]	[mm]	[mm]	[mm]	[mm]	[mm]	[mm]	[mm]	[mm]	[mm]	[mm]	[mm]	[mm]	[kg]	
Ø32	7.0	32	11	4	24	45	30	15.0	142	32.5	32	144	0.08	P1C-4KMF
Ø40	10.0	36	8	4	28	52	30	17.5	161	38.0	36	163	0.09	P1C-4LMF
Ø50	10.0	45	15	5	32	65	36	20.0	170	46.5	45	175	0.18	P1C-4MMF
Ø63	10.0	50	13	5	32	75	35	22.5	185	56.5	50	190	0.20	P1C-4NMF
Ø80	12.0	63	14	6	41	95	47	22.5	210	72.0	63	215	0.40	P1C-4PMF
Ø100	14.5	71	16	6	41	115	53	27.5	220	89.0	75	230	0.54	P1C-4QMF
Ø125	16.5	90	25	8	45	140	70	30.0	250	110.0	90	270	1.10	P1C-4RMF

*Does not apply to cylinders with piston rod extension or lock units.

** per bracket

Pivot Bracket with Rigid Bearing - AB7



Intended for flexible mounting of cylinder. The pivot bracket can be combined with clevis bracket MP2.

Materials:

Pivot bracket: Aluminium
 Bush: Steel and PTFE

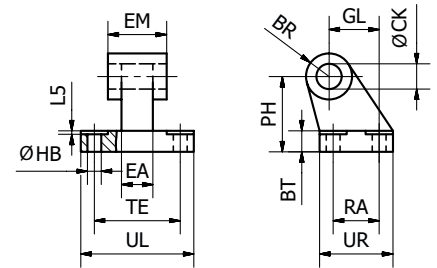

According to ISO 15552

Cyl.-bore	CK	HB	L5	TE	UL	GL	RA	EA	EM	UR	PH	BT	BR	Weight	Order code
[mm]	[mm]	[mm]	[mm]	[mm]	[mm]	[mm]	[mm]	[mm]	[mm]	[mm]	[mm]	[mm]	[mm]	[kg]	
Ø32	10	6.6	1.6	38	51	21	18	10	26	31	32	8	10.0	0.05	P1C-4KMDB
Ø40	12	6.6	1.6	41	54	24	22	15	28	35	36	10	11.0	0.09	P1C-4LMDB
Ø50	12	9.0	1.6	50	65	33	30	16	32	45	45	12	13.0	0.16	P1C-4MMDB
Ø63	16	9.0	1.6	52	67	37	35	16	40	50	50	14	15.0	0.20	P1C-4NMDB
Ø80	16	11.0	2.5	66	86	47	40	20	50	60	63	14	15.0	0.32	P1C-4PMDB
Ø100	20	11.0	2.5	76	96	55	50	20	60	70	71	17	19.0	0.53	P1C-4QMDB
Ø125	25	14.0	3.2	94	124	70	60	30	70	90	90	20	22.5	1.01	P1C-4RMDB

Swivel Eye Bracket - MP6



Intended for use together with clevis bracket AB6.

Materials:

Bracket: Aluminium
 Swivel bearing acc. to DIN 648K:
 Hardened steel

Supplied complete with mounting screws for attachment to cylinder.

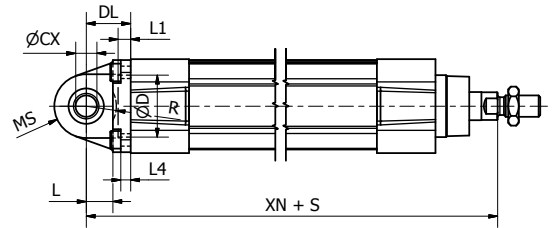
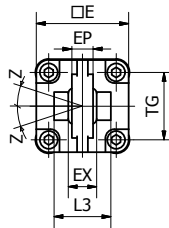

According to ISO 15552

Cyl.-bore	CX	D	DL	E	EP	EX	L	L1	L3	L4	MS	R	TG	XN	Z	Weight	Order code
[mm]	[mm]	[mm]	[mm]	[mm]	[mm]	[mm]	[mm]	[mm]	[mm]	[mm]	[mm]	[mm]	[mm]	[mm]		[kg]	
Ø32	10	30	22	45	10.5	14	12	7	-	5.5	16	-	32.5	142	4°	0.09	P1C-4KMSB
Ø40	12	35	25	52	12	16	15	7	-	5.5	18	-	38	160	4°	0.13	P1C-4LMSB
Ø50	16	40	27	65	15	21	15	7	51	6.5	21	19	46.5	170	4°	0.24	P1C-4MMSB
Ø63	16	45	32	75	15	21	20	7	-	6.5	23	-	56.5	190	4°	0.29	P1C-4NMSB
Ø80	20	45	36	95	18	25	20	9	74	10	28	24	72	210	4°	0.59	P1C-4PMSB
Ø100	20	55	41	115	18	25	25	9	140	10	30	32	89	230	4°	0.78	P1C-4QMSB
Ø125	30	60	50	140	25	37	30	9	-	10	40	-	110	275	4°	1.38	P1C-4RMSB

Clevis Bracket - MP2



Intended for flexible mounting of cylinder.
Can be combined with clevis bracket MP4 and pivot bracket with rigid bearing AB7.

Materials:

Clevis bracket: Aluminium
Pin: Surface hardened steel
Locking pin: Spring steel
Circlips according to DIN 471:
Spring steel
Mounting screws acc. to DIN 912:
Zinc-plated steel 8.8

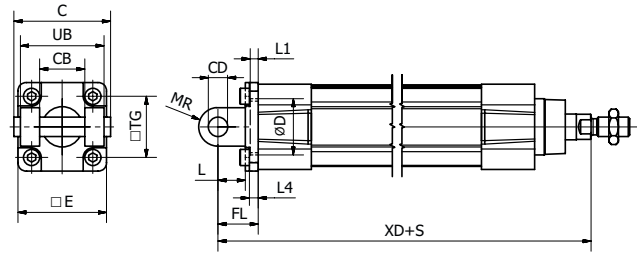

Supplied complete with mounting screws for attachment to the cylinder.

According to ISO 15552

Cyl.-bore	C	E	UB	CB	TG	FL	L1	L	L4	D	CD	MR	XD	Weight	Order code
[mm]	[mm]	[mm]	[mm]	[mm]	[mm]	[mm]	[mm]	[mm]	[mm]	[mm]	[mm]	[mm]	[mm]	[kg]	
Ø32	53	45	45	26	32.5	22	5	13	5.5	30	10	10	142	0.08	P1C-4KMTB
Ø40	60	52	52	28	38	25	5	16	5.5	35	12	12	160	0.10	P1C-4LMTB
Ø50	68	65	60	32	46.5	27	5	16	6.5	40	12	12	170	0.18	P1C-4MMTB
Ø63	78	75	70	40	56.5	32	5	21	6.5	45	16	16	190	0.24	P1C-4NMTB
Ø80	98	95	90	50	72	36	5	22	10	45	16	16	210	0.49	P1C-4PMTB
Ø100	118	115	110	60	89	41	5	27	10	55	20	20	230	0.73	P1C-4QMTB
Ø125	139	140	130	70	110	50	7	30	10	60	25	25	275	1.37	P1C-4RMTB

*Does not apply to cylinders with piston rod extension or lock units.

Clevis Bracket - MP4



Intended for flexible mounting of cylinder. Clevis bracket MP4 can be combined with clevis bracket MP2.

Materials:

Clevis bracket: Aluminium
Bush: PTFE
Mounting screws acc. to DIN 912:
Zinc-plated steel 8.8

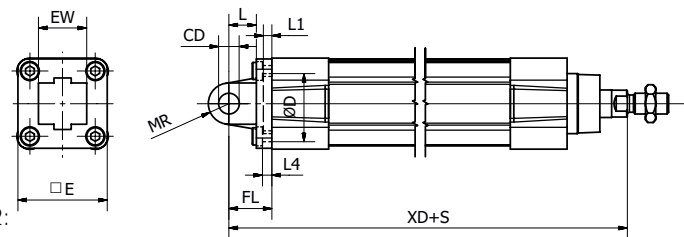

Supplied complete with mounting screws for attachment to the cylinder.

According to ISO 15552

Cyl.-bore	CD	D	E	EW	FL	L	L1	L4	MR	TG	XD	Weight	Order code
[mm]	[mm]	[mm]	[mm]	[mm]	[mm]	[mm]	[mm]	[mm]	[mm]	[mm]	[mm]	[kg]	
Ø32	10	30	47	26	22	12	6.5	6	10.5	32.5	142	0.08	P1C-4KMEB
Ø40	12	35	52	28	25	16	5	5.5	12	38	160	0.11	P1C-4LMEB
Ø50	12	40	65	32	27	16	5	6.5	12	46.5	170	0.18	P1C-4MMEB
Ø63	16	45	78	40	32	21	5	6.5	16	56.5	190	0.28	P1C-4NMEB
Ø80	16	45	95	50	36	22	5	10	16	72	210	0.52	P1C-4PMEB
Ø100	20	55	115	60	41	27	5	10	20	89	230	0.79	P1C-4QMEB
Ø125	25	60	140	70	50	30	7	10	25	110	275	1.46	P1C-4RMEB

*Does not apply to cylinders with piston rod extension or lock units.

Clevis Bracket - AB6



Intended for flexible mounting of cylinder.
Clevis bracket AB6 can be combined with pivot brackets MP6 and CS7 or swivel rod eye AP6.

Materials:

Clevis bracket: Aluminium
Pin: Surface hardened steel
Locking pin: Spring steel
Circlips according to DIN 471: Spring steel
Mounting screws acc. to DIN 912: Zinc-plated steel 8.8
Supplied complete with mounting screws for attachment to the cylinder.

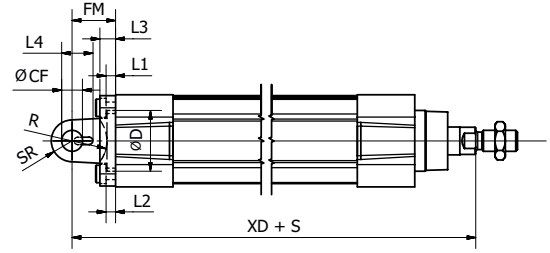
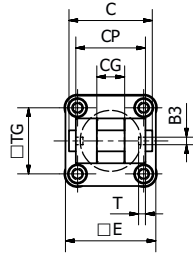

According to ISO 15552

Cyl-bore	B3	C	CF	CG	CP	D	E	FM	I2	T	R	L1	L4	L3	SR	TG	XD*	Weight	Order code
[mm]	[mm]	[mm]	[mm]	[mm]	[mm]	[mm]	[mm]	[mm]	[mm]	[mm]	[mm]	[mm]	[mm]	[mm]	[mm]	[mm]	[mm]	[kg]	
Ø32	3.3	41	10	14	34	30	45	22	5.5	3	17	5	16.5	9	10	32.5	142	0.04	P1C-4KMCB
Ø40	4.3	48	12	16	40	35	52	25	5.5	4	20	5	18	9	12	38	160	0.07	P1C-4LMCB
Ø50	4.3	54	16	21	45	40	65	27	6.5	4	22	5	22	11	14	46.5	170	0.11	P1C-4MMCB
Ø63	4.3	60	16	21	51	45	75	32	6.5	4	25	5	22	11	18	56.5	190	0.19	P1C-4NMCB
Ø80	4.3	75	20	25	65	45	95	36	10.0	4	30	5	26	14	20	72	210	0.38	P1C-4PMCB
Ø100	6.3	85	20	25	75	55	115	41	10.0	4	32	5	26	14	22	89	230	0.61	P1C-4QMCB
Ø125	6.3	110	30	37	97	60	140	50	10.0	6	42	7	39	20	25	110	275	1.10	P1C-4RMCB

Pivot Bracket with Swivel Bearing - CS7



Intended for use together with clevis bracket AB6.

Materials:

Pivot bracket: Surface-treated steel
Swivel bearing acc. to DIN 648K:
Hardened steel

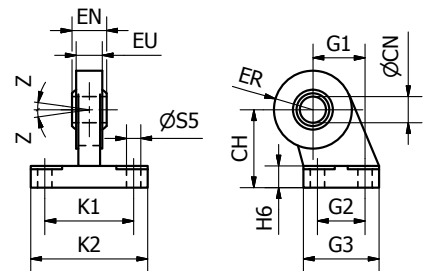

According to ISO 15552

Cyl.-bore	CN	S5	K1	K2	EU	G1	G2	EN	G3	CH	H6	ER	Z	Weight	Order code
[mm]	[mm]	[mm]	[mm]	[mm]	[mm]	[mm]	[mm]	[mm]	[mm]	[mm]	[mm]	[mm]	[mm]	[kg]	
Ø32	10	6.6	38	51	10.5	21	18	14	31	32	10	15	4°	0.18	P1C-4KMAF
Ø40	12	6.6	41	54	12.0	24	22	16	35	36	10	18	4°	0.27	P1C-4LMAF
Ø50	16	9.0	50	65	15.0	33	30	21	45	45	12	20	4°	0.46	P1C-4MMAF
Ø63	16	9.0	52	67	15.0	37	35	21	50	50	12	23	4°	0.55	P1C-4NMAF
Ø80	20	11.0	66	86	18.0	47	40	25	60	63	14	27	4°	0.97	P1C-4PMAF
Ø100	20	11.0	76	96	18.0	55	50	25	70	71	15	30	4°	1.33	P1C-4QMAF
Ø125	30	13.5	94	124	25.0	70	60	37	90	90	20	40	4°	3.00	P1C-4RMAF

*Does not apply to cylinders with piston rod extension or lock units.

3 and 4 Position Flange - JP1



Mounting kit for back to back mounted cylinders, 3 and 4 position cylinders.

Materials:
Mounting: Aluminium
Mounting screws: Zinc-plated steel 8.8

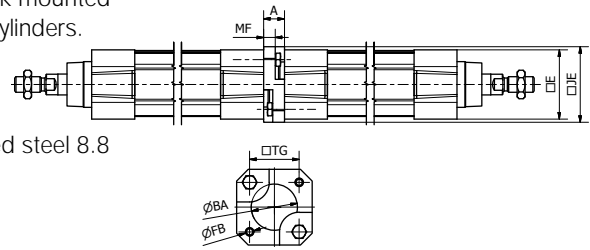

Cyl.-bore	A	ØBA	E	ØFB	JE	MF	TG	Weight	Order code
[mm]	[mm]	[mm]	[mm]	[mm]	[mm]	[mm]	[mm]	[kg]	
Ø32	16	30	47	6.5	50	9	32.5	0.04	P1E-6KB0
Ø40	16	35.5	53	6.5	58	9	38.0	0.07	P1E-6LB0
Ø50	20	40.5	64.5	8.5	66	6	46.5	0.08	P1E-6MB0
Ø63	20	45.5	75	8.5	80	6	56.5	0.16	P1E-6NB0
Ø80	25	45.5	94	10.5	99	8	72.0	0.30	P1E-6PB0
Ø100	25	55.5	111	10.5	118	8	89.0	0.54	P1E-6QB0

Pivot Brackets for MT Trunnion - AT4



Intended for use together with trunnion MT4.

Materials:
Pivot bracket: Surface-treated aluminium
Bush: Bronze
Supplied in pairs

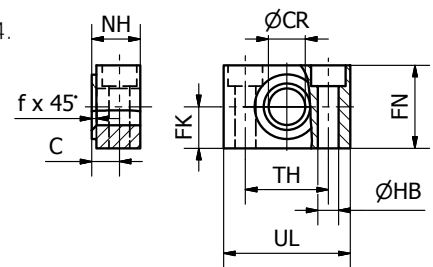

According to ISO 15552

Cyl.-bore	UL	NH	TH	C	CR	HB	FN	FK	fx45°	Weight	Order code
[mm]	[mm]	[mm]	[mm]	[mm]	[mm]	[mm]	[mm]	[mm]	[mm]	[kg]	
Ø32	46	18	32	10.5	12	6.6	30	15	1.0	0.08	9301054261
Ø40	55	21	36	12.0	16	9	36	18	1.6	0.14	9301054262
Ø50	55	21	36	12.0	16	9	36	18	1.6	0.14	9301054262
Ø63	65	23	42	13.0	20	11	40	20	1.6	0.21	9301054264
Ø80	65	23	42	13.0	20	11	40	20	1.6	0.21	9301054264
Ø100	75	28.5	50	16.0	25	14	50	25	2.0	0.36	9301054266
Ø125	75	28.5	50	16.0	25	14	50	25	2.0	0.36	9301054266

Flange Trunnion - MT5 / MT6



Intended for articulated mounting of cylinder. This trunnion can be flange mounted on the front or rear end cover of the cylinder.

Materials:

Trunnion: Zinc-plated steel
Screws: Zinc-plated steel 8.8
Delivered complete with mounting screws for attachment to the cylinder.

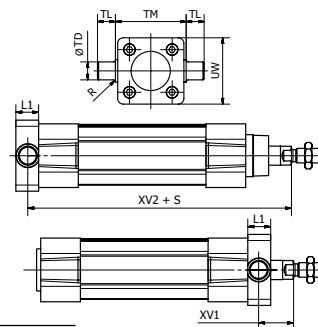

According to ISO 15552

Cyl.-bore	L1	R	TD _(e9)	TL _(h14)	TM _(h14)	UW	XV1*	XV2*	Weight	Order code
[mm]	[mm]	[mm]	[mm]	[mm]	[mm]	[mm]	[mm]	[mm]	[kg]	
Ø32	14	1.0	12	12	50	46	19.5	127.0	0.14	P1D-4KMYF
Ø40	19	1.6	16	16	63	59	21.0	144.5	0.39	P1D-4LMYF
Ø50	19	1.6	16	16	75	69	28.0	152.5	0.51	P1D-4MMYF
Ø63	24	1.6	20	20	90	84	25.5	170.0	1.04	P1D-4NMYF
Ø80	24	1.6	20	20	110	102	34.5	186.0	1.57	P1D-4PMYF
Ø100	29	2.0	25	25	132	125	37.0	203.5	3.00	P1D-4QMYF

*Does not apply to cylinders with piston rod extension or lock units.

To fit a flange mounted trunnion at the front end cover of a cylinder with lock unit, the piston rod must be extended. This is in order to provide the same WH dimensions as for the P1F base cylinder.

Centre Trunnion - MT4

Centre Trunnion Smooth Profile Tube



Available for P1F Profile and tie rod versions the MT4 centre trunnion when combined with AT4 pivot brackets is intended for articulated mounting of the cylinder. The trunnion is free so that it can be fixed afterward when the cylinder is at the right place on the machine.

Material: Zinc plated steel

Centre Trunnion Tie-Rods Tube

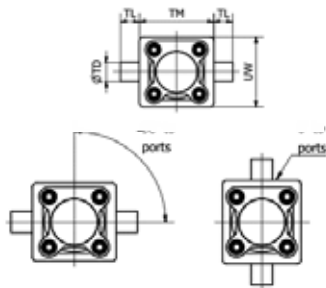

Trunnion loose. The centre trunnion can also be supplied loosely fitted to the cylinder (not fixed in position). This allows the position to be set at the time of installation. Order with a letter / number in position 17 and 000 in positions 18-20. Please refer to the order code key. Note: No decimals are used in positions 18-20.

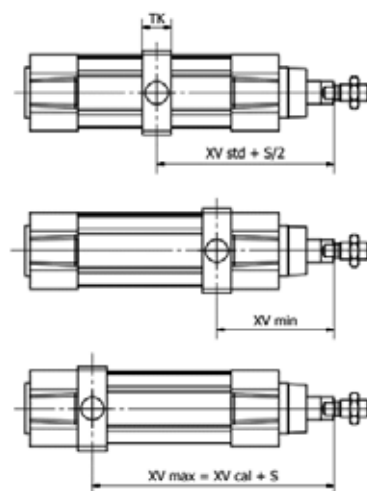

According to ISO 15552

Cyl.-bore	TL _{h14}	TM _{h14}	ØTD _{e9}	XV _{std}	P1F-S/K				P1F-T/N				P1F-L	P1F-H	Order Code	
					TK	UW	XV _{min}	XV _{cal}	TK	UW	XV _{min}	XV _{cal}			Adder to XV	
[mm]	[mm]	[mm]	[mm]	[mm]	[mm]	[mm]	[mm]	[mm]	[mm]	[mm]	[mm]	[mm]	[mm]	[mm]	Smooth Profile	Tie-Rods
Ø32	12	50	12	73.0	18	52	78.0	68.0	15	46	63.0	83.0	32.0	48.0	P1F-4KMY	P1F-4KMYT
Ø40	16	63	16	83.0	20	60	84	81.0	20	59	74.0	91.0	30.0	55.0	P1F-4LMY	P1F-4LMYT
Ø50	16	75	16	90.0	20	71	97	83.0	20	69	82.0	98.0	29.0	70.0	P1F-4MMY	P1F-4MMYT
Ø63	20	90	20	98.0	26	84	100	95.0	25	84	90.0	105.0	39.0	70.0	P1F-4NMY	P1F-4NMYT
Ø80	20	110	20	110.0	26	105	116	104.0	25	102	99.0	121.0	45.0	90.0	P1F-4PMY	P1F-4PMYT
Ø100	25	132	25	120.0	32	129	122	118.0	30	125	112.0	128.0	57.0	92.0	P1F-4QMY	P1F-4QMYT
Ø125	25	160	25	145.0	33	154	157	133.0	33	155	134.0	156.0	56.0	122.0	P1F-4RMY	P1F-4RMYT

Swivel Rod Eye - AP6



Swivel rod eye for articulated mounting of the cylinder. Swivel rod eye can be combined with clevis bracket AB6.

Materials:

Swivel rod eye: Zinc-plated steel
Swivel bearing according to DIN 648K: hardened steel

Swivel rod eye: Stainless steel
Swivel bearing according to DIN 648K: Hardened steel

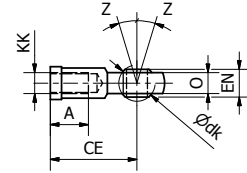
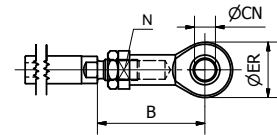

According to ISO 8139

Cyl.-bore	A	B _{min}	B _{max}	CE	CN	EN	ER	KK	LE dk	N	O	Z	Weight	Order Code	
														Galvanised steel	Stainless steel
Ø32	15	48.0	55	43	10	14	29	M10x1.25	19.0	17	10.5	13°	0.07	P1C-4KRS	P1S-4JRT
Ø40	18	56.0	62	50	12	16	33	M12x1.25	22.2	19	12.0	13°	0.11	P1C-4LRS	P1S-4LRT
Ø50	24	72.0	80	64	16	21	43	M16x1.5	28.5	22	15.0	15°	0.21	P1C-4MRS	P1S-4MRT
Ø63	24	72.0	80	64	16	21	43	M16x1.5	28.5	22	15.0	15°	0.21	P1C-4MRS	P1S-4MRT
Ø80	30	87.0	97	77	20	25	51	M20x1.5	34.9	30	18.0	15°	0.38	P1C-4PRS	P1S-4PRT
Ø100	30	87.0	97	77	20	25	51	M20x1.5	34.9	30	18.0	15°	0.38	P1C-4PRS	P1S-4PRT
Ø125	45	123.5	137	110	30	37	70	M27x2	50.8	41	25.0	15°	1.15	P1C-4RRS	P1S-4RRT

Clevis - AP2



Clevis for articulated mounting of the cylinder.

Materials:

Clevis, clip: Zinc-plated steel
Pin: Hardened steel

Clevis, clip: Stainless steel
Pin: Stainless steel

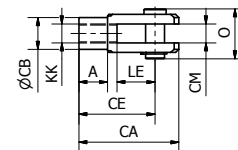
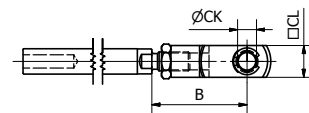

According to ISO 15552

Cyl.-bore	A	B _{min}	B _{max}	CA	CB	CE	CK	CL	CM	KK	LE	O	Weight	Order code	
														Galvanised steel	Stainless steel
Ø32	15	45	52	52	18	40	10	20	10	M10x1.25	20	25	0.09	P1C-4KRC	P1S-4JRD
Ø40	18	54	60	62	20	48	12	24	12	M12x1.25	24	31	0.15	P1C-4LRC	P1S-4LRD
Ø50	24	72	80	83	26	64	16	32	16	M16x1.5	32	40	0.34	P1C-4MRC	P1S-4MRD
Ø63	24	72	80	83	26	64	16	32	16	M16x1.5	32	40	0.34	P1C-4MRC	P1S-4MRD
Ø80	30	90	100	105	34	80	20	40	20	M20x1.5	40	50	0.67	P1C-4PRC	P1S-4PRD
Ø100	30	90	100	105	34	80	20	40	20	M20x1.5	40	50	0.67	P1C-4PRC	P1S-4PRD
Ø125	40	123.5	137	148	48	110	30	55	30	M27x2.0	54	65	1.80	P1C-4RRC	P1S-4RRD

Flexo Coupling - PM5



Flexo coupling for articulated mounting of piston rod. Flexo fitting is intended to take up axial angle errors within a range of $\pm 4^\circ$.

Materials:

Flexo coupling, nut: Zinc-plated steel

Supplied complete with galvanized adjustment nut.

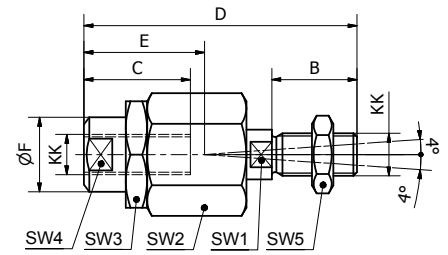

Cyl. bore	KK	B	C	D	E	ØF	SW1	SW2	SW3	SW4	SW5	Weight	Order code
[mm]		[mm]	[mm]	[mm]	[mm]	[mm]	[mm]	[mm]	[mm]	[mm]	[mm]	[kg]	
Ø32	M10x1.25	20	23	70	31	21	12	30	30	19	17	0.23	P1C-4KRF
Ø40	M12x1.25	24	30	77	31	21	12	30	30	19	19	0.23	P1C-4LRF
Ø50	M16x1.5	32	32	108	45	33.5	19	41	41	30	24	0.65	P1C-4MRF
Ø63	M16x1.5	32	32	108	45	33.5	19	41	41	30	24	0.65	P1C-4MRF
Ø80	M20x1.5	40	42	122	56	33.5	19	41	41	30	30	0.71	P1C-4PRF
Ø100	M20x1.5	40	42	122	56	33.5	19	41	41	30	30	0.71	P1C-4PRF
Ø125	M27x2	54	48	147	51	39	24	55	55	32	41	1.60	P1C-4RRF

Piston Rod Nuts - MR9

All P1F cylinders are delivered with a zinc plated steel piston rod nut unless specified below.



Material: Zinc-plated steel



Material: Stainless steel A2

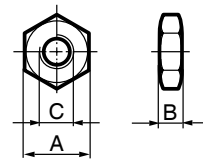

According to DIN 439 B

Cyl.-bore	A	B	C	Weight	Order code	
					Zinc plated steel	Stainless steel
[mm]	[mm]	[mm]	[mm]	[kg]		
Ø32	17	5.0	M10 x 1.25	0.007	P14-4KRPZ	P14-4KRPS
Ø40	19	6.0	M12 x 1.25	0.010	P14-4LRPZ	P14-4LRPS
Ø50	24	8.0	M16 x 1.5	0.021	P14-4MRPZ	P14-4MRPS
Ø63	24	8.0	M16 x 1.5	0.021	P14-4MRPZ	P14-4MRPS
Ø80	30	10.0	M20 x 1.5	0.040	P14-4PRPZ	P14-4PRPS
Ø100	30	10.0	M20 x 1.5	0.040	P14-4PRPZ	P14-4PRPS
Ø125	41	13.5	M27 x 2.0	0.100	P14-4RRPZ	P14-4RRPS

*Weight per item

Drop-in sensors

The P8S sensors can easily be installed from the side in the sensor groove, at any position along the piston stroke. The sensors are completely recessed and thus mechanically protected. Choose between electronic or reed sensors and several cable lengths and 8 mm and M12 connectors.



Electronic sensors

The electronic sensors are "Solid State", i.e. they have no moving parts at all. They are provided with short-circuit protection and transient protection as standard. The built-in electronics make the sensors suitable for applications with high on and off switching frequency, and where very long service life is required.

Reed sensors

The sensors are based on proven reed switches, which offer reliable function in many applications. Simple installation, a protected position on the cylinder and clear LED indication.

	Electronic	Reed
Cylinder type:	Profile with T-slot	
Cylinder type with adaptor:	Profile with S-slot (dovetail) Tie rods Round cylinders	
Installation:	Drop-in. Fixed by 1.5 mm stainless steel allen key or flathead screwdriver.	
Housing length:	34.7 mm 31.5 mm (ATEX)	
Output Type / Function:	PNP, Normally Open (NO) NPN, Normally Closed (NC)	Normally Open (NO) Normally Closed (NC)
Switching (on/off) switching frequency:	≤1000 Hz	± 400 Hz
Degree of Protection (IP):	IP67	
Power consumption:	≤ 10 mA	-
Input Supply Voltage Range:	10 to 30 V DC 18 to 30 V DC (ATEX)	10 to 30 10 to 120 10 to 230 V AC/DC (2-wire) 10 to 30 V AC/DC (3-wire)
Voltage Drop:	≤ 2,2 V	≤ 3,5 V (2-wire NO) ≤ 0,1 V (3-wire) ≤ 0,1 V (2-wire NC)
Continuous output current:	≤ 100 mA ≤ 70 mA (ATEX)	≤ 100 mA (2-wire NO) ≤ 500 mA (3-wire) ≤ 500 mA (2-wire NC)
Switching capacity:	-	≤ 10 W
Hazardous area category:	3G / 3D (ATEX)	-
Protection Class:	III	II (2-wire) III (3-wire)
Response Sensitivity:	2.65.. 2.95 mT	2.1.. 3.4 mT
Overrun Distance:	3 mm	9 mm
Hysteresis:	≤ 0.5 mT	≤ 0.2 mT
Repeatability:	≤ 0.1 mT	-
Reverse Polarity Protection:	Yes	-
Short-circuit Protection:	Yes	-
Power-up Pulse Protection:	Yes	-
Ambient Operating Temperature Range:	-25 to +75 °C (PUR cable) -20 to +70°C (PVC cable) -20 to +45°C (ATEX)	
Shock and Vibration resistance:	30 g 11 ms / 10 ... 55 Hz, 1 mm	
EMC:	According to EN 60947-5-2	
Industry Standard:	CE C UL US RoHs Ex	CE C UL US RoHs
UL Certification:	On request	
Housing Material:	Plastic polyamid PA12 (ATEX) PA66	Plastic polyamid PA12 (2-wire 240V) PA66
Cable Specification:	PUR (Polyurethane) PVC (Polyvinyl Chloride)	
Conductor Cross-Section:	0.14 mm ² (3 wire)	0.14 mm ² (3-wire) 0.12 mm ² (2-wire)
Colour of LED:	Yellow	
Connection Style:	M8 snap-in M8R (knurled nuts) M12 (knurled nuts) None (Flying lead)	

PDE3570TCEN Pneumatic Cylinders ISO 15552

Electronic sensors

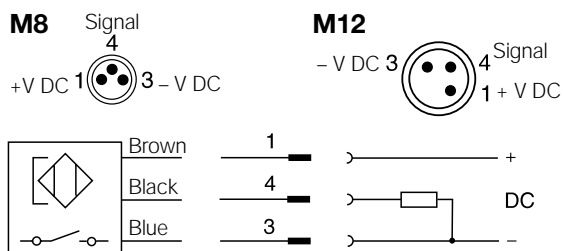

Reed sensors

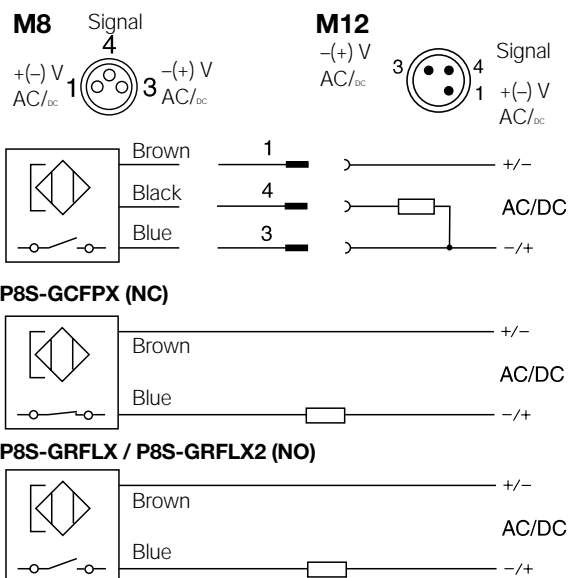

Dimensions [mm]

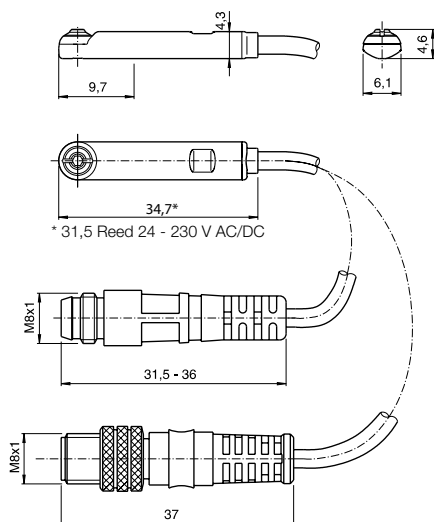

Sensor Installation

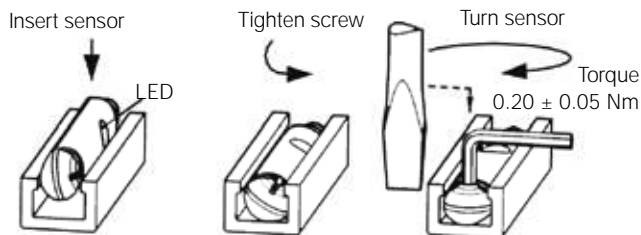

Brackets for sensors for Tie-Rods version

Oder code: PD48955 - bores Ø32 to Ø100 mm

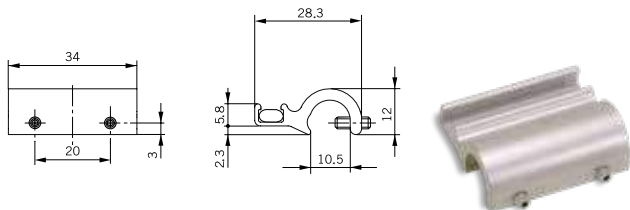

Oder code: PD48956 - bore Ø125 mm

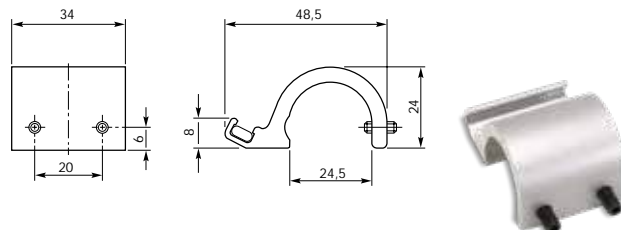

Ordering data

Output/function	Cable/connector	Weight [kg]	Order code
Electronic sensors, 10-30 V DC			
PNP type, normally open	0.27 m PUR cable and 8 mm snap-in male connector	0.007	P8S-GPSHX
PNP type, normally open	0.27 m PUR cable and M12 screw male connector	0.015	P8S-GPMHX
PNP type, normally open	3 m PVC cable without connector	0.030	P8S-GPFLX
PNP type, normally open	10 m PVC cable without connector	0.110	P8S-GPFTX
Reed sensors, 10-30 V AC/DC			
Normally open	0.27 m PUR cable and 8 mm snap-in male connector	0.007	P8S-GSSHX
Normally open	0.27 m PUR cable and M12 screw male connector	0.015	P8S-GSMHX
Normally open	3 m PVC cable without connector	0.030	P8S-GSFLX
Normally open	10 m PVC cable without connector	0.110	P8S-GSFTX
Normally closed	5 m PVC cable without connector without LED	0.050	P8S-GCFPX
Reed sensors, 10-120 V AC/DC			
Normally open	3 m PVC cable without connector	0.030	P8S-GRFLX
Reed sensors, 24-230 V AC/DC			
Normally open	3 m PVC cable without connector	0.030	P8S-GRFLX2

Male connectors for connecting cables

Cable connectors for producing your own connecting cables. The connectors can be quickly attached to the cable without special tools. Only the outer sheath of the cable is removed. The connectors are available for M8 screw connectors and meet protection class IP 65.



Technical data

Operating voltage:	max. 32V AC/DC
Operating current per contact:	max. 4 A
Connection cross section:	0.25.... 0.5 mm ² (conductor diameter min 0.1)
Protection class:	IP65 And IP 67 when plugged and screwed down (EN 60529)
Temperature range:	- 25... +85°C

Connector	Weight [kg]	Order Code
M8 screw connector	0.018	P8CS0803J
M12 screw connector	0.022	P8CS1204J

Connecting cables

Description	Weight [g]	For Product Series	Order Code
Cable flex PVC 3 meter with 8mm snap-in connector / flying leads	70	P8S Sensors with M8	9126344341
Cable flex PVC 10 meter with 8mm snap-in connector / flying leads	210	P8S Sensors with M8	9126344342
Cable PUR 3 meter with 8mm snap-in female connector / flying leads	70	P8S Sensors with M8	9126344345
Cable flex PUR 10 meter with 8mm snap-in connector / flying leads	210	P8S Sensors with M8	9126344346
Cable PVC 2.5 meter with M8 screw connector / flying leads	60	P8S Sensors with knurled M8	KC3102
Cable PVC 5 meter with M8 screw female connector / flying leads	120	P8S Sensors with knurled M8	KC3104

Continuous Position Sensing

Analogue signal or IO-Link communication for linear cylinders many applications require more than just end of stroke sensing of an actuator, but traditional methods of continuous sensing are expensive and difficult to implement. Parker's CPS series of the P8S sensor family enables quick, easy, precise, and contactless position sensing of a piston. This can be installed on a standard linear actuator and offers an outstanding price to performance ratio.

Product Features:

Continuous position sensing

- IO-Link communication with M12 connector
- No modification to the actuator
- Analogue version with M8 connector
- 5 sizes with sensing ranges from 32 mm to 256 mm
- IP67 design suitable for any industrial application
- Yellow teach button for easy set-up

Technical specification:

1 ms sampling rate
 0.03% full scale resolution
 0.06% full scale repeatability
 0.3 mm Linearity error

How it installs:

The Parker CPS requires the use of a magnetic piston. The product will fit T-slot cylinders without any additional mounting hardware.

1. Pivot the sensor into the slot
2. Teach the CPS unit the desired measuring range
3. Tighten set screws

Dimensions in mm (inch)

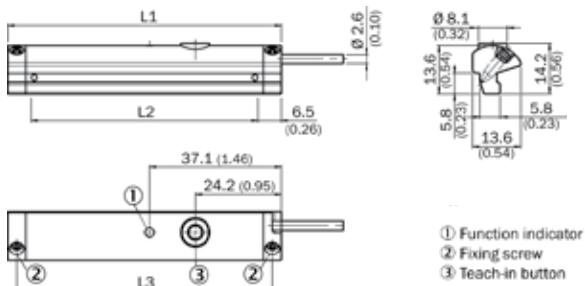

How it connects:

Analogue version has a M8 connector and a voltage output of 0-10V as well as a current output of 4-20mA. IO-Link version has a M12 connector and transmits position via 2 bytes of process input data and also allows for parameter control of measuring range and locking of the teach button. It can be controlled by Class A or Class B IO-Link Masters.

How it works:

The CPS product detects the position of an actuator via the magnet on the piston. The sensor settings can easily be adjusted during installation using the yellow teach button or during operation over the IO-Link communication. This upgrades the functionality of the pneumatic actuator by making it more intelligent and versatile in support of the Industry 4.0 initiative.

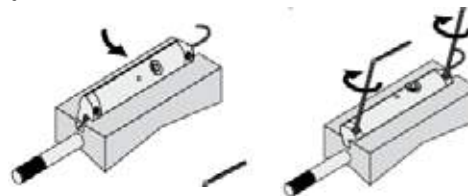

Order Code				
L1	L2 *	L3	Analogue	IO-Link
45	32	40	P8SAGACHA	P8SAGHMHA
77	64	72	P8SAGACHB	P8SAGHMHB
141	128	136	P8SAGACHD	P8SAGHMHD
205	192	200	P8SAGACHF	P8SAGMHMF
269	256	264	P8SAGACHH	P8SAGMHMH

*L2 equal to the measuring range

Ordering Data

Drop in T-slot, Turn, Screw, it's done

Output	Measuring length	Configuration Option	Order Code	Weight [g]	For product series
Analogue	32 mm	Teach Button	P8SAGACHA	16	With T-slot groove *
	64 mm		P8SAGACHB	26	
	128 mm		P8SAGACHD	46	
	192 mm		P8SAGACHF	66	
	256 mm		P8SAGACHH	86	
IO-Link	32 mm	Teach Button or IO-Link parameter	P8SAGHMHA	20	With T-slot groove *
	64 mm		P8SAGHMHB	30	
	128 mm		P8SAGHMHD	50	
	192 mm		P8SAGMHMF	70	
	256 mm		P8SAGMHMH	90	

* Required magnetic field sensitivity: 3mT / -2 mT (Analogue) / 3mT (IO-Link)

Note: PUR cable with M12 (IO-Link) or M8 (Analogue) male connector knurled nut, 4-pin, 0,3 meter length. Please consult for measuring range 96, 160 & 224 mm.

Seal Kits

Complete seal kits consisting of:

- 2 piston seals.
- 2 cushioning seals.
- 1 wiper / piston rod seal.
- 2 O-Rings.

Greases

	Standard	30 g	9127394541
	High temperature	30 g	9127394521
	Low temperature	30 g	9127394541

Cyl.-bore [mm]	Standard temperature ¹⁾	High temperature ¹⁾	Low temperature ¹⁾	Metallic scraper ¹⁾²⁾	FKM Wiper seal ¹⁾	With dyn. rod lock ¹⁾	With static rod lock ¹⁾
Ø32	P1F-6032RN	P1F-6032RF	P1F-6032RL	P1F-6032RQ	P1F-6032RV	P1F-6032RNL	P1F-6032RNH
Ø40	P1F-6040RN	P1F-6040RF	P1F-6040RL	P1F-6040RQ	P1F-6040RV	P1F-6040RNL	P1F-6040RNH
Ø50	P1F-6050RN	P1F-6050RF	P1F-6050RL	P1F-6050RQ	P1F-6050RV	P1F-6050RNL	P1F-6050RNH
Ø63	P1F-6063RN	P1F-6063RF	P1F-6063RL	P1F-6063RQ	P1F-6063RV	P1F-6063RNL	P1F-6063RNH
Ø80	P1F-6080RN	P1F-6080RF	P1F-6080RL	P1F-6080RQ	P1F-6080RV	P1F-6080RNL	P1F-6080RNH
Ø100	P1F-6100RN	P1F-6100RF	P1F-6100RL	P1F-6100RQ	P1F-6100RV	P1F-6100RNL	P1F-6100RNH
Ø125	P1F-6125RN	P1F-6125RF	P1F-6125RL	P1F-6125RQ	P1F-6125RV	P1F-6125RNL	P1F-6125RNH

¹⁾ for through piston rod, add K at the end, ie P1F-6032RNK

²⁾ -30 to +80°C

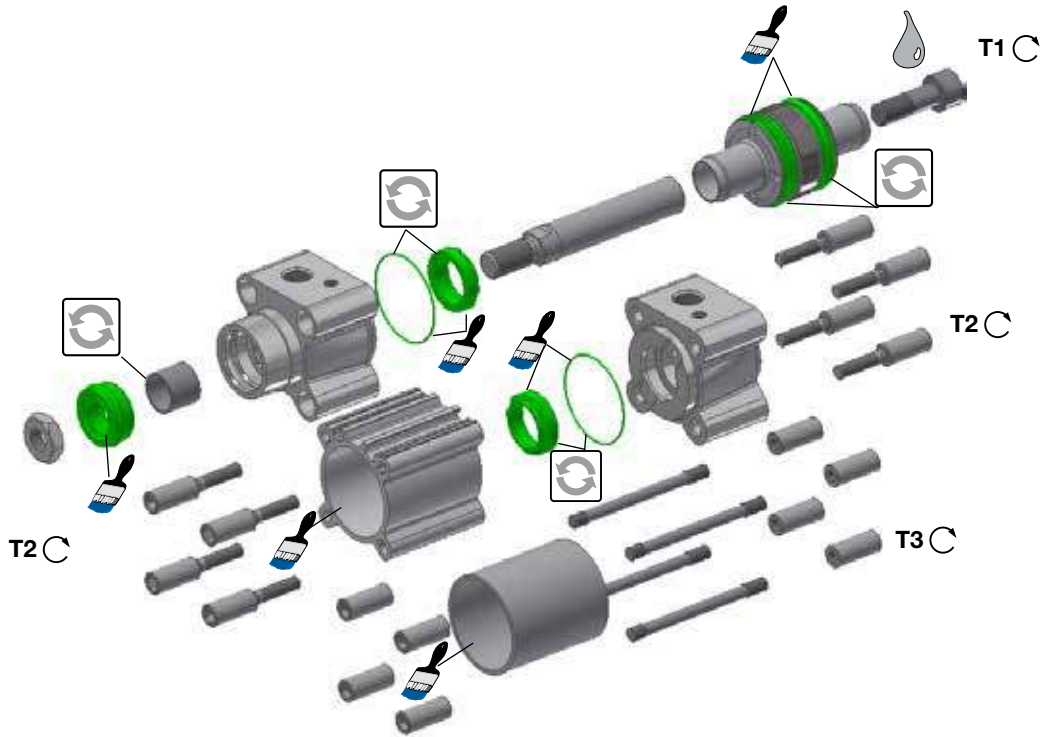

Cyl.-bore [mm]	Plastic piston T1 [Nm]	Al Piston T1 [Nm]	AF [mm]	T2 [Nm]	AF [mm]	T3 [Nm]
Ø32	4.5	15	6	8	6	6
Ø40	11	30	8	8	6	6
Ø50	20	40	10	20	8	11
Ø63	20	40	10	20	8	11
Ø80	40	120	14	20	6	20
Ø100	120	120	14	20	6	20
Ø125	120	120	14	70	8	40



= Included in seal kit



= Socket head across flats



= Tightening torque



Lubricated with grease



Locking fluid
 Loctite 270 or Loctite 2701 locking fluid must be used

Specifying air quality (purity) in accordance with ISO8573-1:2010, the international standard for compressed air quality

ISO8573-1 is the primary document used from the ISO8573 series as it is this document which specifies the amount of contamination allowed in each cubic metre of compressed air.

ISO8573-1 lists the main contaminants as Solid Particulate, Water and Oil. The purity levels for each contaminant are shown separately in tabular form, however for ease of use, this document combines all three contaminants into one easy to use table.

ISO8573-1:2010 CLASS	Solid Particulate				Water		Oil
	Maximum number of particles per m ³			Mass Concentration mg/m ³	Vapour Pressure Dewpoint	Liquid g/m ³	Total Oil (aerosol liquid and vapour) mg/m ³
	0,1 - 0,5 micron	0,5 - 1 micron	1 - 5 micron				
0	As specified by the equipment user or supplier and more stringent than Class 1						
1	≤ 20 000	≤ 400	≤ 10	-	≤ -70 °C	-	0,01
2	≤ 400 000	≤ 6 000	≤ 100	-	≤ -40 °C	-	0,1
3	-	≤ 90 000	≤ 1 000	-	≤ -20 °C	-	1
4	-	-	≤ 10 000	-	≤ +3 °C	-	5
5	-	-	≤ 100 000	-	≤ +7 °C	-	-
6	-	-	-	≤ 5	≤ +10 °C	-	-
7	-	-	-	5 - 10	-	≤ 0,5	-
8	-	-	-	-	-	0,5 - 5	-
9	-	-	-	-	-	5 - 10	-
X	-	-	-	> 10	-	> 10	> 10

Specifying air purity in accordance with ISO8573-1:2010

When specifying the purity of air required, the standard must always be referenced, followed by the purity class selected for each contaminant (a different purity class can be selected for each contamination if required).

An example of how to write an air quality specification is shown below:

ISO 8573-1:2010 Class 1.2.1

ISO 8573-1:2010 refers to the standard document and its revision, the three digits refer to the purity classifications selected for solid particulate, water and total oil. Selecting an air purity class of 1.2.1 would specify the following air quality when operating at the standard's reference conditions:

Class 1 - Particulate

In each cubic metre of compressed air, the particulate count should not exceed 20,000 particles in the 0.1 - 0.5 micron size range, 400 particles in the 0.5 - 1 micron size range and 10 particles in the 1 - 5 micron size range.

Class 2 - Water

A pressure dewpoint (PDP) of -40°C or better is required and no liquid water is allowed.

Class 1 - Oil

In each cubic metre of compressed air, not more than 0.01mg of oil is allowed. This is a total level for liquid oil, oil aerosol and oil vapour.

ISO8573-1:2010 Class zero

- **Class 0 does not mean zero contamination.**
- **Class 0 requires the user and the equipment manufacturer to agree contamination levels as part of a written specification.**
- **The agreed contamination levels for a Class 0 specification should be within the measurement capabilities of the test equipment and test methods shown in ISO8573 Pt 2 to Pt 9.**
- **The agreed Class 0 specification must be written on all documentation to be in accordance with the standard.**
- **Stating Class 0 without the agreed specification is meaningless and not in accordance with the standard.**
- **A number of compressor manufacturers claim that the delivered air from their oil-free compressors is in compliance with Class 0.**
- **If the compressor was tested in clean room conditions, the contamination detected at the outlet will be minimal. Should the same compressor now be installed in typical urban environment, the level of contamination will be dependent upon what is drawn into the compressor intake, rendering the Class 0 claim invalid.**
- **A compressor delivering air to Class 0 will still require purification equipment in both the compressor room and at the point of use for the Class 0 purity to be maintained at the application.**
- **Air for critical applications such as breathing, medical, food, etc typically only requires air quality to Class 2.2.1 or Class 2.1.1.**
- **Purification of air to meet a Class 0 specification is only cost effective if carried out at the point of use.**

Parker Worldwide

Europe, Middle East, Africa

AE – United Arab Emirates, Dubai
Tel: +971 4 8127100
parker.me@parker.com

AT – Austria, Wiener Neustadt
Tel: +43 (0)2622 23501-0
parker.austria@parker.com

AT – Eastern Europe, Wiener Neustadt
Tel: +43 (0)2622 23501 900
parker.easteurope@parker.com

AZ – Azerbaijan, Baku
Tel: +994 50 2233 458
parker.azerbaijan@parker.com

BE/LU – Belgium, Nivelles
Tel: +32 (0)67 280 900
parker.belgium@parker.com

BG – Bulgaria, Sofia
Tel: +359 2 980 1344
parker.bulgaria@parker.com

BY – Belarus, Minsk
Tel: +48 (0)22 573 24 00
parker.poland@parker.com

CH – Switzerland, Etoy
Tel: +41 (0)21 821 87 00
parker.switzerland@parker.com

CZ – Czech Republic, Klecany
Tel: +420 284 083 111
parker.czechrepublic@parker.com

DE – Germany, Kaarst
Tel: +49 (0)2131 4016 0
parker.germany@parker.com

DK – Denmark, Ballerup
Tel: +45 43 56 04 00
parker.denmark@parker.com

ES – Spain, Madrid
Tel: +34 902 330 001
parker.spain@parker.com

FI – Finland, Vantaa
Tel: +358 (0)20 753 2500
parker.finland@parker.com

FR – France, Contamine s/Arve
Tel: +33 (0)4 50 25 80 25
parker.france@parker.com

GR – Greece, Athens
Tel: +30 210 933 6450
parker.greece@parker.com

HU – Hungary, Budaörs
Tel: +36 23 885 470
parker.hungary@parker.com

IE – Ireland, Dublin
Tel: +353 (0)1 466 6370
parker.ireland@parker.com

IL – Israel
Tel: +39 02 45 19 21
parker.israel@parker.com

IT – Italy, Corsico (MI)
Tel: +39 02 45 19 21
parker.italy@parker.com

KZ – Kazakhstan, Almaty
Tel: +7 7273 561 000
parker.easteurope@parker.com

NL – The Netherlands, Oldenzaal
Tel: +31 (0)541 585 000
parker.nl@parker.com

NO – Norway, Asker
Tel: +47 66 75 34 00
parker.norway@parker.com

PL – Poland, Warsaw
Tel: +48 (0)22 573 24 00
parker.poland@parker.com

PT – Portugal
Tel: +351 22 999 7360
parker.portugal@parker.com

RO – Romania, Bucharest
Tel: +40 21 252 1382
parker.romania@parker.com

RU – Russia, Moscow
Tel: +7 495 645-2156
parker.russia@parker.com

SE – Sweden, Spånga
Tel: +46 (0)8 59 79 50 00
parker.sweden@parker.com

SL – Slovenia, Novo Mesto
Tel: +386 7 337 6650
parker.slovenia@parker.com

TR – Turkey, Istanbul
Tel: +90 216 4997081
parker.turkey@parker.com

UA – Ukraine, Kiev
Tel: +48 (0)22 573 24 00
parker.poland@parker.com

UK – United Kingdom, Warwick
Tel: +44 (0)1926 317 878
parker.uk@parker.com

ZA – South Africa, Kempton Park
Tel: +27 (0)11 961 0700
parker.southafrica@parker.com

North America

CA – Canada, Milton, Ontario
Tel: +1 905 693 3000

US – USA, Cleveland
Tel: +1 216 896 3000

Asia Pacific

AU – Australia, Castle Hill
Tel: +61 (0)2-9634 7777

CN – China, Shanghai
Tel: +86 21 2899 5000

HK – Hong Kong
Tel: +852 2428 8008

IN – India, Mumbai
Tel: +91 22 6513 7081-85

JP – Japan, Tokyo
Tel: +81 (0)3 6408 3901

KR – South Korea, Seoul
Tel: +82 2 559 0400

MY – Malaysia, Shah Alam
Tel: +60 3 7849 0800

NZ – New Zealand, Mt Wellington
Tel: +64 9 574 1744

SG – Singapore
Tel: +65 6887 6300

TH – Thailand, Bangkok
Tel: +662 186 7000

TW – Taiwan, Taipei
Tel: +886 2 2298 8987

South America

AR – Argentina, Buenos Aires
Tel: +54 3327 44 4129

BR – Brazil, Sao Jose dos Campos
Tel: +55 800 727 5374

CL – Chile, Santiago
Tel: +56 2 623 1216

MX – Mexico, Toluca
Tel: +52 72 2275 4200

European Product Information Centre

Free phone: 00 800 27 27 5374

(from AT, BE, CH, CZ, DE, DK, EE, ES, FI, FR, IE, IL, IS, IT, LU, MT, NL, NO, PL, PT, RU, SE, SK, UK, ZA)

