



aerospace
climate control
electromechanical
filtration
fluid & gas handling
hydraulics
pneumatics
process control
sealing & shielding





Logic processing

Catalogue PDE2619TCUK October 2009



ENGINEERING YOUR SUCCESS.

 **Important !**
Before carrying out any service work, ensure that the valve and manifold have been vented. Remove the primary supply air hose to ensure total disconnection of the air supply before dismantling valves or blank connection blocks.

 **NB !**
All technical data in this catalogue is typical only. The air quality is decisive for the valve life: see ISO 8573.

 **WARNING**
FAILURE OR IMPROPER SELECTION OR IMPROPER USE OF THE PRODUCTS AND/OR SYSTEMS DESCRIBED HEREIN OR RELATED ITEMS CAN CAUSE DEATH, PERSONAL INJURY AND PROPERTY DAMAGE.
This document and other information from Parker Hannifin Corporation, its subsidiaries and authorized distributors provide product and/or system options for further investigation by users having technical expertise. It is important that you analyze all aspects of your application and review the information concerning the product or system in the current product catalog. Due to the variety of operating conditions and applications for these products or systems, the user, through its own analysis and testing, is solely responsible for making the final selection of the products and systems and assuring that all performance, safety and warning requirements of the application are met. The products described herein, including without limitation, product features, specifications, designs, availability and pricing, are subject to change by Parker Hannifin Corporation and its subsidiaries at any time without notice.

SALE CONDITIONS
The items described in this document are available for sale by Parker Hannifin Corporation, its subsidiaries or its authorized distributors. Any sale contract entered into by Parker will be governed by the provisions stated in Parker's standard terms and conditions of sale (copy available upon request).

Summary	Page
Summary.....	3
Presentation.....	4 - 8
ATEX products.....	9 -11
Panorama - Operating informations.....	12 - 13
Specific characteristics.....	14
Modular sequencer.....	11
Logic elements.....	17
Sub-bases and timers.....	18
Amplifiers and sensor modules.....	19
Electro-modules.....	20
Impulse counters and timers.....	21
Accessories.....	22
Spare parts.....	23
Bases / Cells associations.....	24 - 25
Dimensions.....	26 - 29

Line mounted logic elements

These can either be mounted along the length of the line or located in an enclosure.

Two logic functions are available with this model : AND and OR.



Combinable logic elements

These elements can be combined with each other enabling the assembly of compact logic blocks. Three logic functions are provided : AND - OR and inhibition NOT.

In addition to the combination assembly by integral key, each logic element includes a mode selector which enables, simply by pivoting the selector, a choice between cascade mode or common, input mode :

- cascade mode means that the element output corresponds to the input of the following element ;
- common input mode sends one of the element's inputs to an input of the following element.

The logic block obtained in this way for each applications are mounted in an enclosure on standard Omega rail, are connected by instant connections and carry, on the front, their internal diagram to facilitate any intervention.

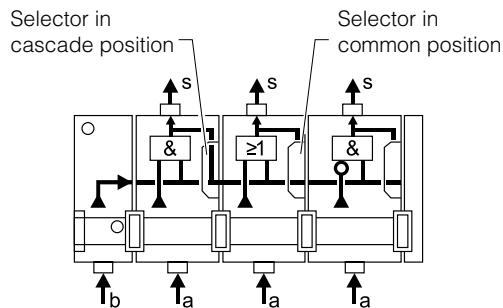
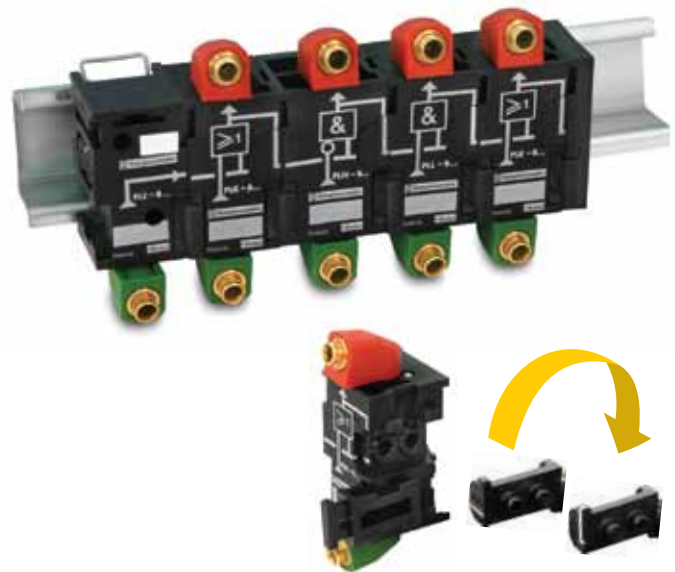

Sub-base mounting logic elements

As an alternative, it is possible to use logic element suitable for mounting on 3-port sub-bases, the interconnections being made by the sub-bases.

The following can be used :

- 3-port sub-bases with common pressure, with common used as "input common" ;
- 3-port "cascade" sub-bases.



The specialized relays mounted on stacking sub-bases are complementary to the sequencers and logic elements.

According to the relay, it can be used a 3-port or a 4-port sub-base.



3-port sub-bases

These are designed for the mounting of :

- timers,
- relays for bleed sensors,
- pressure operated electrical contacts.



4-ports sub-bases

These are designed for the mounting of :

- memory relays,
- amplifier relays for fluidic proximity sensors.

The standard configuration enables the use of a single pressure supply to all the relays by the centre ports ; this is why the stacking "common pressure" sub-bases, with either 3 or 4 ports, are all designed to be used singly or combined in a bank traversed by a pressure common.

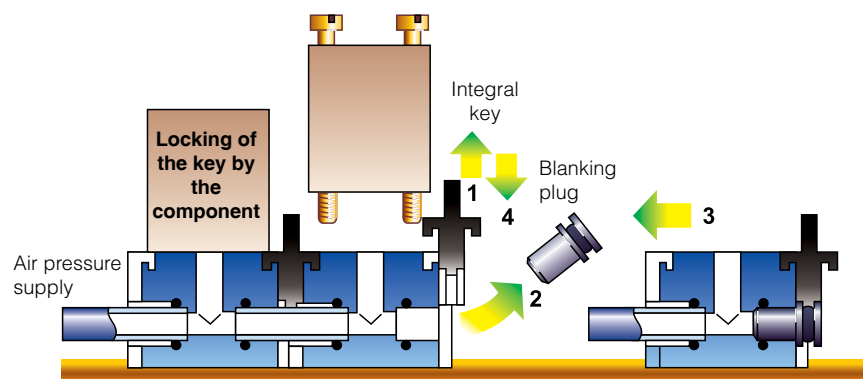

Production machines fitted with pneumatic cylinders generally repeat a defined sequential cycle.

The pneumatic sequencer commands and controls the correct operation of the required cycle.

Composition

The pneumatic sequencer comprises :

- the stage modules corresponding to the cycle to be run : a module is used for each stage of the GRAFCET function chart ;

- the two modules, head and tail, interlock the association of the module onto Omega rail and enable the connection of the pressure common, of the reset to zero and the connection loops between the last and the first module.

A deviation module is fitted between the step modules to intercept the inter-module signals when the cycle includes parallel elements, restarts or the skipping of a step.

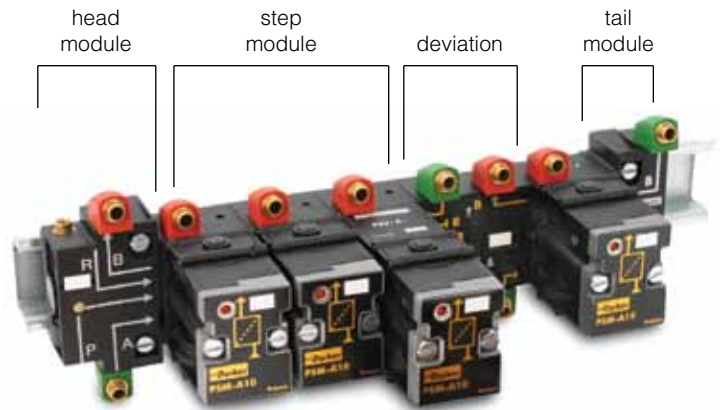

Dialogue

The pneumatic sequencer facilitates the machine adjustment dialogue and the optional dialogue.

At the step module level, dialogue items include :

- a step indicator which signals the step activated ;
- step reference marking ;
- manual overrides for resetting the module to 0 or to 1 ;
- test point, enabling knowledge of the input and output state of each module.

At the closure module level, the reference markings enable :

- connection of loops A and B necessary for cycle repetition ;
- switching on of the sequencer ;
- fitting of a reset (RESET) if the application requires this.

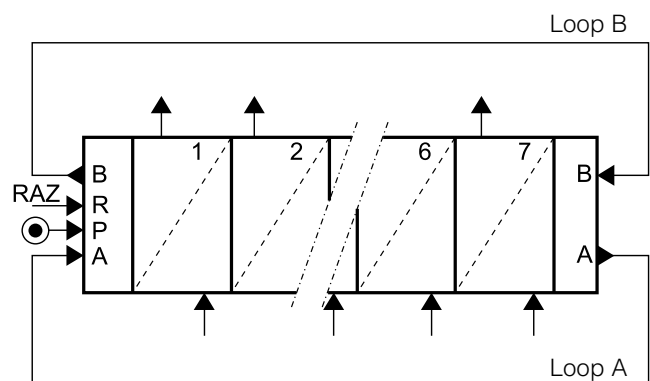
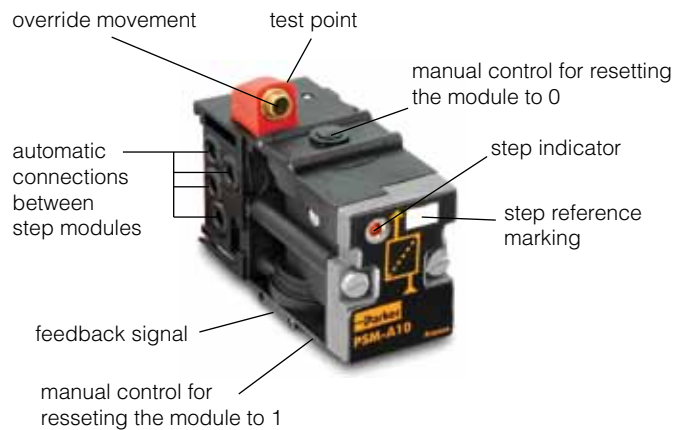

Setting up

The sequencer reproduces the GRAFCET function diagram configuration which defines the operating cycle : a sequencer stage module corresponds to each stage in the cycle.

The activated stage module sends the control signal to the pressure valve controlling the action intended for the stage, then waits for the feedback signal at the end of this action before activating the next stage module in the sequencer.

The all pneumatic loop shown in the diagram revolves in this way around the stage module, the sequencer activating stage by stage each of the actions to be carried out in the cycle order.

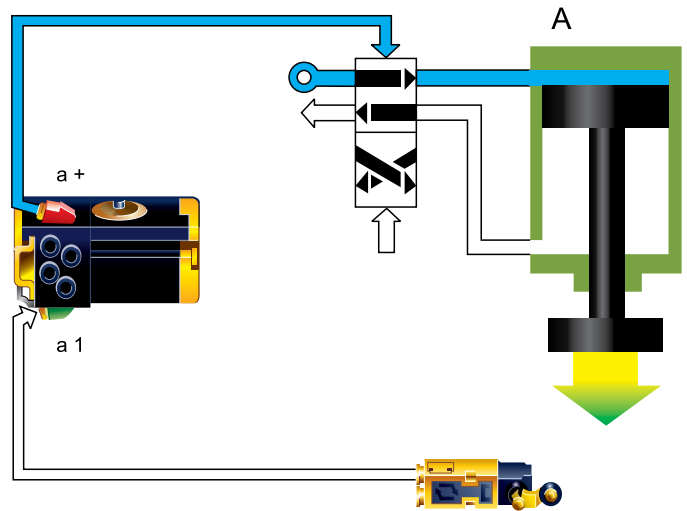

Example

This very simple example shows a pneumatic press fitted with a part supply cylinder.

A bistable power valve and end of travel sensors are associated with each cylinder.

The GRAFCET diagram defines the required cycle. The initial stage is placed at the end to facilitate obtaining the cycle via the sequencer.

In the diagram, the sequencer reproduces the GRAFCET diagram, sending step by step control signals (a+, a-, b+, b-) according to the feedback signals (a1, a0, b1, b0).

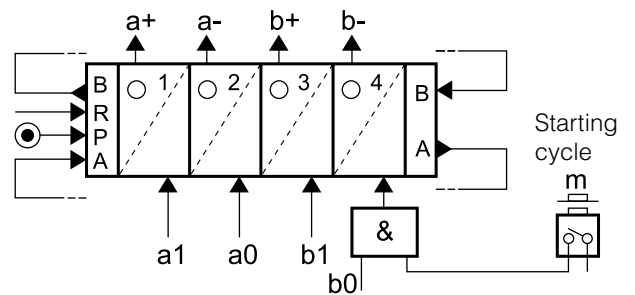
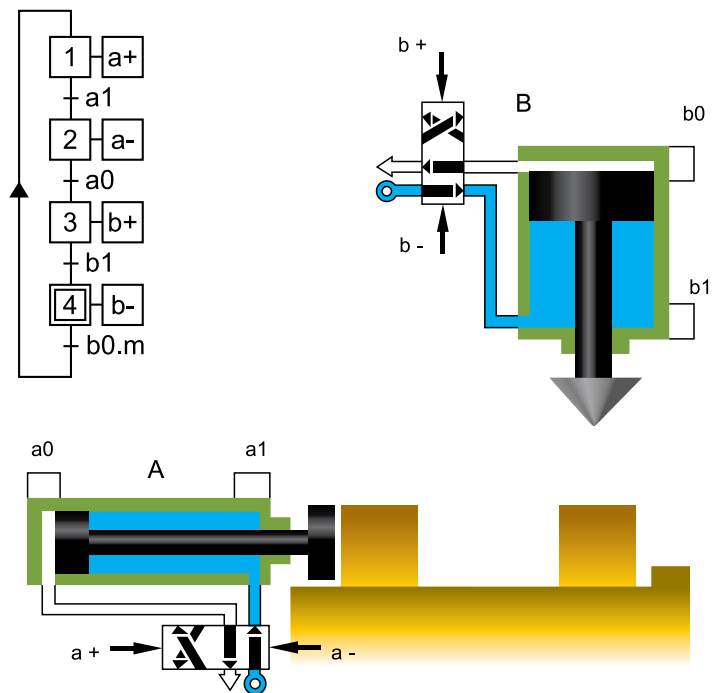

Basic features

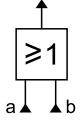
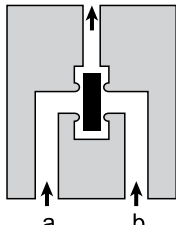
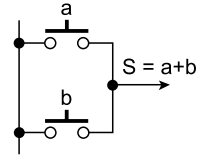
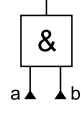
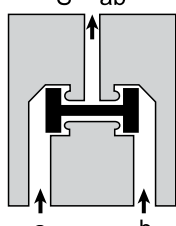
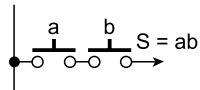
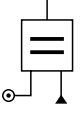
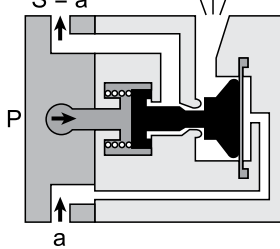
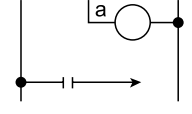
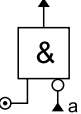
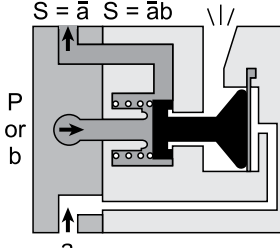
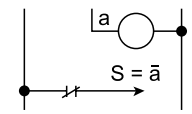
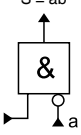
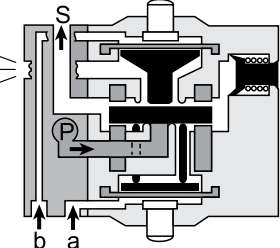
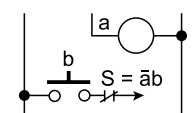
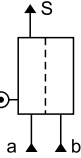
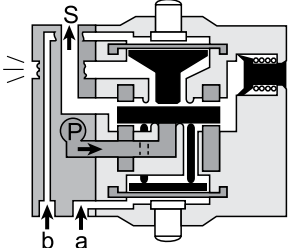
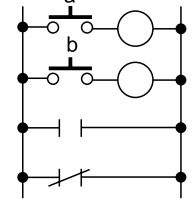
	Logic Function	Logic Symbol	Pneumatic Component	Function Symbol	Electrical Equivalent
PASSIVE FUNCTIONS	OR	$S = a \text{ OR } b$ (or both) $S = a + b$ 	Output S is ON if at least one of the inputs "a" OR "b" is ON.	$S = a + b$ 	
	AND	$S = a \text{ and } b$ $S = ab$ 	Output S is ON only if inputs "a" AND "b" are ON.	$S = ab$ 	
ACTIVE FUNCTIONS	YES (Regenerate)	$S = a$ (Regenerated) 	Output S is ON and regenerated if input "a" is ON.	$S = a$ 	
	NOT (Inhibit)	$S = \text{NOT } a$ $S = \bar{a}$ 	Output S is ON if input "a" is OFF (and if supply P is present).	$S = \bar{a}$ $S = \bar{a}b$ 	
		$S = \bar{a}b$ 	"b" is an intermittent signal. "a" inhibits "b". Output S is ON if "b" is ON and "a" is OFF.		
MEMORY		Input "a" generates output S (SET). Output S remains ON until removed by input "b" (RESET).			

ATEX - Ex products compliance

Some products (**PLL-, PLK-, PLN-, PLJ-, PLM-, PRD-, PRF-, PRT-, PSM-, PSV-A1**) are available certified ATEX Labels II 2 GD c 85 °C zones 1, 2, 21, 22 certification n° LCIE 04 ATEX 6164X.

All these products are marked with * in this technical leaflet.

To obtain the ATEX version of the product, add -EX at the end of the order code Eg : **PSM-A12-EX**

For more information please refer to ATEX Components technical leaflet : PDE2584TCUK-ev

<p>Instruction Leaflet Logic elements </p> <p>1 – SPECIFICATIONS</p> <ul style="list-style-type: none"> • Operating temperature (Ta) -15°C to +60°C (5°F to +140°F) • Fluid temperature -15°C to +60°C (5°F to +140°F) • Operating pressure 3 to 8 bar (45 to 116 psi) • Air condition ISO 8573-1: <ul style="list-style-type: none"> - Filtered air or inert gas class 5 - Dry air or inert gas class 4 • Max Operating Frequency 5 Hz • Operating position Any position <p>2 – MODELS AND FUNCTIONS</p> <table style="width: 100%; border: none;"> <tr> <td style="border: none;">PLL-... / PLK-... / PLN-... / PLJ-C10 / PLM-... / ...</td> <td style="border: none;">Functions AND, OR, NOT, YES and Latch memory,</td> </tr> <tr> <td style="border: none;">PRD-... / PRF-... / PRT-... / ...</td> <td style="border: none;">Amplifier, Sensor, Timer,</td> </tr> <tr> <td style="border: none;">PSM-... / PSV-A12</td> <td style="border: none;">Modular Sequencer.</td> </tr> </table> <p>3 – INSTALLATION</p> <ul style="list-style-type: none"> • Mounting according to the PARKER catalogue, in conjunction with subbases and in put modules: <table style="width: 100%; border: none;"> <tr> <td style="border: none;">PLE-B1 / PZU-.....</td> <td style="border: none;">for functions and latch memory</td> </tr> <tr> <td style="border: none;">PZU-.....</td> <td style="border: none;">for Amplifier, Sensor, Timer,</td> </tr> <tr> <td style="border: none;">PSE-A1 / PSD-... / PSB-A1</td> <td style="border: none;">for Modular Sequencer</td> </tr> </table> <p>WARNING</p> <ul style="list-style-type: none"> • Conditions for installing the components must comply with specifications mentioned in chapters 1 and 3 • Before maintenance operations, stop the air and ensure that pipes are exhausted. Then proceed. • The replacement of a component must be done with a component of the same ATEX category. • Cleaning operations should be done in compliance with the specifications of the ATEX zone, preferably by aspiration and/or utilization of antistatic products. The deposit of dust should not exceed 5 µm. • The installation and maintenance operations must be done by qualified personnel. <p>4 – ATEX CLASSIFICATION</p> <p style="text-align: center;"> II 2 GD c 85 °C</p> <table border="1" style="width: 100%; border-collapse: collapse;"> <tr> <td style="width: 20px; text-align: center;"></td> <td>Specific logo for safety in hazardous atmospheres</td> </tr> <tr> <td style="text-align: center;">II</td> <td>Destination : Group II : Atmospheres other than in mines</td> </tr> <tr> <td style="text-align: center;">2</td> <td>For use in zones 1 and 21</td> </tr> <tr> <td style="text-align: center;">GD</td> <td>Gas or Dust atmospheres</td> </tr> <tr> <td style="text-align: center;">c</td> <td>Protection mode : "c", constructional safety</td> </tr> <tr> <td style="text-align: center;">85°C</td> <td>Temperature class (T8)</td> </tr> </table> <p>The maximum ambient temperature (Ta) of the equipment or of the subassembly incorporating logic elements will be defined as:</p> <ul style="list-style-type: none"> • (Ta) of the element having the lowest limit if this one is < 60°C, • 60°C if elements other than the logic have a (Ta) > 60°C. 	PLL-... / PLK-... / PLN-... / PLJ-C10 / PLM-... / ...	Functions AND, OR, NOT, YES and Latch memory,	PRD-... / PRF-... / PRT-... / ...	Amplifier, Sensor, Timer,	PSM-... / PSV-A12	Modular Sequencer.	PLE-B1 / PZU-.....	for functions and latch memory	PZU-.....	for Amplifier, Sensor, Timer,	PSE-A1 / PSD-... / PSB-A1	for Modular Sequencer		Specific logo for safety in hazardous atmospheres	II	Destination : Group II : Atmospheres other than in mines	2	For use in zones 1 and 21	GD	Gas or Dust atmospheres	c	Protection mode : "c", constructional safety	85°C	Temperature class (T8)	<p style="text-align: center;">EC DECLARATION of CONFORMITY </p> <p>We, Parker Hannifin France S.A.S. Etablissement d'Evreux Rue H. Becquerel – BP 3124 27031 EVREUX CEDEX – France</p> <p>herby declare that the following components from the Telepneumatic pneumatic logic range :</p> <ul style="list-style-type: none"> - PLL-... / PLK-... / PLN-... / PLJ-C10 / Functions AND, OR, NOT, YES, - PLM-... / PRD-... / PRF-... / PRT-... / Latch memory, Amplifier, Sensor, Timer, - PSM-... / PSV-A1. Modular Sequencer, <p>are compatible for use in explosive atmosphere II 2 GD (zones 1,2 and 21,22).</p> <p>These components are designed and manufactured in compliance with the European Directive:</p> <ul style="list-style-type: none"> - 94/9/EC, March 1994, "ATEX" <p>The present declaration is based on the compliance with the following standards:</p> <ul style="list-style-type: none"> - Standard EN 13463-1, 2001 and AC:2002, Non-electrical equipment for potentially explosive atmospheres. Part 1: Basic methods and requirements - Standard EN 13463-5, 2003, Non-electrical equipment intended for use in potentially explosive atmospheres. Part 5: Protection by constructional safety "c". <p>Type certificate: LCIE 04 ATEX 6164X</p> <p>Delivered by: LCIE</p> <p>Additional information: These products are designed for utilization in applications falling under the scope of the ATEX Directive 94/9/EC. This coverage could only be referred to as long as operations for the installation and the maintenance of these products are complying with related standards. The user will have to comply with procedures for getting an approval of the final assembled system according to related regulations.</p> <p style="text-align: center;">Issued at Evreux Date: January 24th, 2007</p> <p>CE marked: 2004</p>
PLL-... / PLK-... / PLN-... / PLJ-C10 / PLM-... / ...	Functions AND, OR, NOT, YES and Latch memory,																								
PRD-... / PRF-... / PRT-... / ...	Amplifier, Sensor, Timer,																								
PSM-... / PSV-A12	Modular Sequencer.																								
PLE-B1 / PZU-.....	for functions and latch memory																								
PZU-.....	for Amplifier, Sensor, Timer,																								
PSE-A1 / PSD-... / PSB-A1	for Modular Sequencer																								
	Specific logo for safety in hazardous atmospheres																								
II	Destination : Group II : Atmospheres other than in mines																								
2	For use in zones 1 and 21																								
GD	Gas or Dust atmospheres																								
c	Protection mode : "c", constructional safety																								
85°C	Temperature class (T8)																								

Introduction to the European ATEX directive Explosive atmospheres

Directive 94/9/EC defines an explosive atmosphere as a mixture of :

- a) **flammable substances** – gases, vapours, mists or dusts
 - b) with **air**
 - c) under specific **atmospheric conditions**
 - d) in which, after ignition has occurred, combustion spreads to the entire flammable mixture
- (NB: with regard to dust, it may be that not all dust is combusted after ignition has occurred)

An atmosphere with the potential to become an explosive atmosphere during operating conditions and/or under the influence of the surroundings is defined as a **potentially explosive atmosphere**. Products covered by directive 94/9/EC are defined as intended for use in potentially explosive atmospheres.

Harmonised European ATEX standard

The European Union has adopted two harmonised directives in the field of health and safety. The directives are known as ATEX 100a and ATEX 137.

Directive ATEX 100a (94/9/EC) lays down minimum safety requirements for products intended for use in potentially explosive atmospheres in European Union member states. Directive ATEX 137 (99/92/EC) defines minimum requirements for health and safety at the workplace, for working conditions and for the handling of products and materials in potentially explosive atmospheres. This directive also divides the workplace into **zones** and defines criteria by which products are **categorised** within these zones.

The table below describes the **zones** in an installation where there is a potential for explosive atmospheres. The **owner** of the installation must analyse and assess the area in which the explosive gas/dust mixture may occur, and if necessary must divide it into **zones**. This process of zoning then allows the correct plant and equipment to be selected for use in the area.

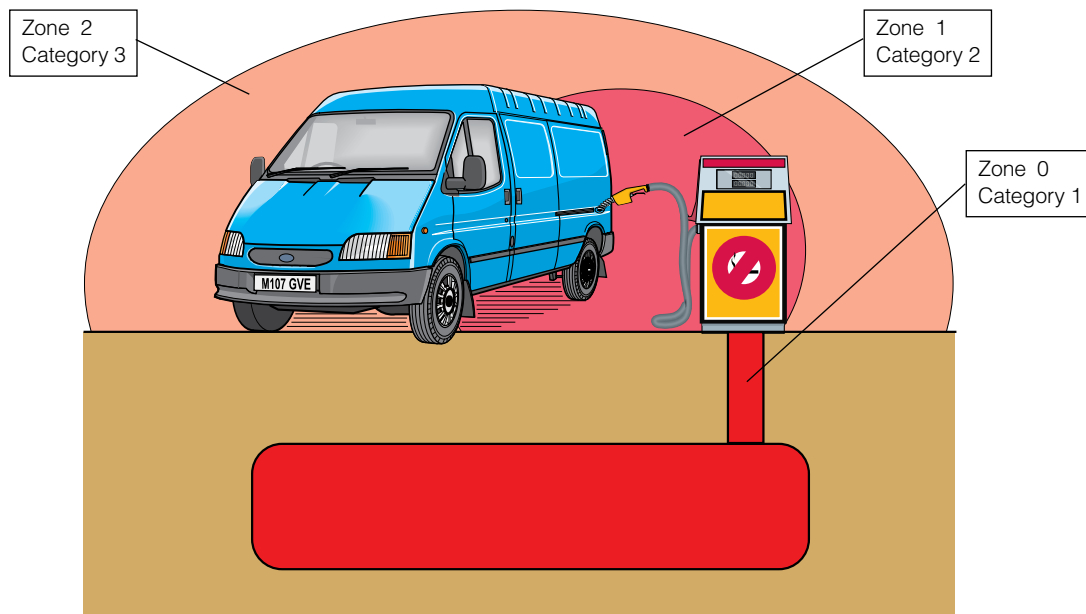

Zones		Presence of potentially explosive atmosphere	Type of risk
Gas G	Dust D		
0	20	Present continuously or for long periods.	Permanent.
1	21	Likely to occur in normal operation occasionally.	Potential.
2	22	Not likely to occur in normal operation but, if it does occur, will persist for a short period only.	Minimal.

The ATEX directive has been in force throughout the European Union since 1 July 2003, replacing the existing divergent national and European legislation relating to explosive atmospheres.

Please note that for the first time, the directive covers mechanical, hydraulic and pneumatic equipment and not just electrical equipment as before.

With regard to the **Machinery directive 98/37/EC**, note that a number of external requirements in 94/9/EC refer to hazards arising from potentially explosive atmospheres, where the Machinery directive only contains general requirements relating to explosion safety (Annex I 1.5.7).

As a result, directive 94/9/EC (ATEX 100a) takes precedence over the Machinery directive with regard to explosion protection in potentially explosive atmospheres. The requirements in the Machinery directive are applicable to all other risks relating to machinery.

In most cases full certification is not required, a much more simple "Risk Assessment" as detailed in the Directive, for the products to be supplied will suffice. At the moment we are conducting "Risk Assessments" in accordance with the Directive, on a broad range of core products which will be published on the web site. A more limited range of products will have the full ATEX certification where this is deemed necessary.

Levels of protection for the various equipment categories

The various equipment categories must be capable of operating in accordance with the manufacturer’s operating specifications at defined levels of protection.

Level of protection	Category		Type of protection	Operating specifications
	Group I	Group II		
Very high	M1		Two independent means of protection or safety, ensuring that the equipment remains functional even in the event of two faults occurring independently of each other.	The equipment remains energised and functional even with an explosive atmosphere present.
Very high		1	Two independent means of protection or safety, ensuring that the equipment remains functional even in the event of two faults occurring independently of each other.	The equipment remains energised and functional in zones 0, 1, 2 (G) and/or zones 20, 21, 22 (D).
High	M2		Protection suitable for normal operation and severe operating conditions.	The equipment is de-energised in the event of an explosive atmosphere.
High		2	Protection suitable for normal operation and frequent faults, or equipment in which faults normally have to be taken into account.	The equipment remains energised and functional in zones 1, 2 (G) and/or zones 21, 22 (D).
Normal		3	Protection suitable for normal operation.	The equipment remains energised and functional in zones 2 (G) and/or zones 22 (D).

Definition of groups (EN 1127-1)

Group I Equipment intended for use in underground parts of mines as well as those parts of surface installations of such mines likely to be endangered by flammable vapours and/or flammable dusts.

Group II Equipment intended for use in other places exposed to explosive atmospheres.

Group	I		II					
	mines, combustible vapours		other potentially explosive atmospheres (gases, dust)					
Category	M1	M2	1		2		3	
Atmosphere*			G	D	G	D	G	D
Zone			0	20	1	21	2	22

* G = gas and D = dust

Temperature classes

Classification of flammable gases and vapours on the basis of ignition temperature.

Temperature class	Maxi. allowed temperature on the surface of the material (°C)
T1	450
T2	300
T3	200
T4	135
T5	100
T6	85

Parker components out of scope of the ATEX Directive :

Essential elements with the reliable use of the products and protection systems, but not having an autonomous function nor an own ignition source.

Declaration of conformity

The product catalogues contain copies of the declaration of conformity demonstrating that the product meets the requirements of directive 94/9/EC.

The declaration is only valid in conjunction with the instructions contained in the installation manual relating to the safe use of the product throughout its service life.

The instructions relating to the conditions in the surrounding area are particularly important, as the certificate is invalidated if the instructions are found not to have been adhered to during operation of the product.

If there is any doubt as to the validity of the certificate of conformity, contact Parker Hannifin customer service.

Operation, installation and maintenance

The product installation manual contains instructions relating to the safe storage, handling, operation and servicing of the product.

The manual is available in different languages, and can be downloaded from www.parker.com/euro_pneumatic.

This document must be made accessible in a suitable place near where the product is installed. It is used as a reference for all personnel authorised to work with the product throughout its service life.

We, the manufacturer, reserve the right to modify, extend or improve the installation manual in the interests of the users.

For more information about ATEX see EUs homepage: <http://europa.eu.int/comm/enterprise/atex/>

Pneumatic automation; Control module

**Time delay
Relay**

**Relay
function**

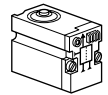
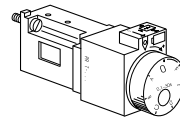
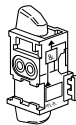
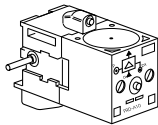

Series	PSM, PLM	PLL, PLK	PLL, PLK	PLN-D, PLJ	PRT	PLM
Function	Modular sequencer	Stand alone logic cell	Stackable logic cell	Subbase mtd logic cell	Time relay Pneum. Relay	Memory Relay
Operating Pressure	3 to 8 bar	3 to 8 bar	3 to 8 bar	3 to 8 bar	3 to 8 bar	3 to 8 bar
Storage temperature	-40 °C to +70 °C	-40 °C to +70 °C	-40 °C to +70 °C	-40 °C to +70 °C	-40 °C to +70 °C	-40 °C to +70 °C
Working temperature	-15 °C to +60 °C	-15 °C to +60 °C	-15 °C to +60 °C	-15 °C to +60 °C	-15 °C to +60 °C	-15 °C to +60 °C
Flow, NI/min at 6 bar	180	180	180	90/180	180	180
Flow, Kv	1,8	1,8	1,8	1/1,8	1,8	1,8
Response time	Commuting time of the primary acting cell: 2 to 3 ms					
Mechanical life at 6 bar, 20 °C 1 Hz	10 million cycles	100 million cycles	100 million cycles	10 million cycles	10 million cycles	10 million cycles
Shocks and Vibrations	According to IEC 68-2-6 and IEC 68-2-27					
Connection	Push-in connection Ø4 mm					
Mounting	All positions	All positions	All positions	All positions	All positions	All positions
Refer to page	15	16	17	17	18	19

Material

Valve member - seat :	Self lubricating acetal - ceramic
Body :	Polyamide reinforced fibreglass
Casing - End plates :	Anodised aluminium
Valve plate :	Zamak
Seals :	Nitrile
Springs :	Stainless steel
Screws :	Stainless steel
Poppets :	Polyuréthane

General Characteristics

Fluid :	Air or inert gas filtered 40 µ class 5 according to ISO 8573-1 dry class according to service temperature non-lubricated, or lubricated
Storage temperature :	-40 °C to + 70 °C
Low temperature climatic :	According to EN 60068-2-1, test Ad
High temperature climatic :	According to EN 60068-2-2, test Bd
Shock and Vibrations :	According to IEC 68-2-6 and IEC 68-2-27
Salt spray test :	According to ISO 9227, 168 h
Solenoid orifice :	1.2/1.3mm
Power (DC) :	6 to 6.8W
Voltage tolerance :	+/- 30%
Duty cycle :	100%
Electrical connection :	Din A

Relay functions	Pressure Switch	Solenoid Actuator	Counters and Timers			
------------------------	------------------------	--------------------------	----------------------------	--	--	--

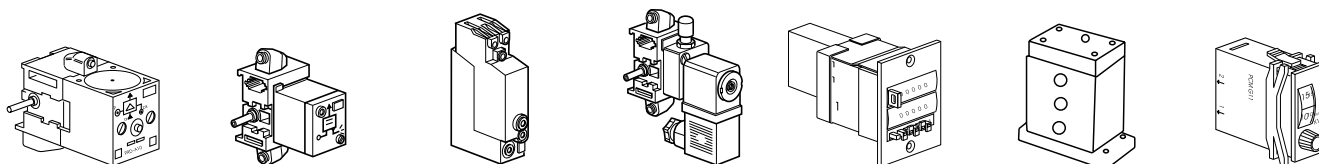

PRD	PRF	PRE, PS1	PRS	PCT, PCP	2147	PCM
Amplifier relay	Sensor relay	Pressure switch	Solenoid actuator	Counter	Binary Counter	Timers
3 to 8 bar	3 to 8 bar	3 to 8 bar	3 to 8 bar	2 to 8 bar	0 to 10 bar	2 to 6 bar
-40 °C to +70 °C	-40 °C to +70 °C	-40 °C to +70 °C	-40 °C to +70 °C	0 °C to +60 °C	0 °C to +70 °C	-40 °C to +70 °C
-15 °C to +60 °C	-15 °C to +60 °C	-15 °C to +60 °C	-15 °C to +40 °C	0 °C to +60 °C		0 °C to +60 °C
90	180	-	60	-	460	100
1	1,8	-	0,65	-	-	-
Commuting time of the primary acting cell: 2 to 3 ms		2 to 3 ms	8 to 12 ms	Reset time 150 ms	Reset time 200 ms	
10 million cycles	10 million cycles	10 million cycles	10 million cycles	10 million cycles	50 million cycles	5 million cycles

According to IEC 68-2-6 and IEC 68-2-27

Push-in connection Ø4 mm

All positions	All positions	All positions	All positions	All positions	All positions	All positions
19	19	20	20	21	21	21

Specific characteristics**PRD**

Signal pressure (a) :	0,5 to 2 mbar (maximum permissible overpressure = 200 mbar)
Auxiliary supply pressure (p) :	100 to 200 mbar
Consumption :	at 100 mbar with a = 0 : 3l/min ANR
Operating frequency :	10 Hz (with manual control)

PRF

Operating pressure :	3 to 8 bar
Nozzle Ø :	0,3 mm
Nozzle consumption :	2 NI/min per bar

PRS

Consumption :	Direct current : sealed = 5 W	Alternating current : sealed = 6 VA ; inrush = 20 VA
Voltage range :	0,9 to 1,05 Un	
Standard voltages :	24 VDC ; 48 VDC ; 24 VAC ; 115 VAC ; 230 VAC	
Rating :	100 %	
Connection :	Plug-in connector, Ø 9 mm cable entry, terminal capacity 1,5 mm ²	
Nominal insulation voltage :	660 V AC or V DC (with manual control)	
Protection degree :	IP 65	



PRE

Trip pressure :	2,2 to 3 bar
Depilot pressure :	2 to 2,6 bar
Max. operating frequency :	10 Hz
Nominal insulation voltage :	660 V AC or V DC
Nominal thermal rating :	10 A
Protection degree :	IP 65
Connection :	Plug-in connector, Ø 9 mm cable entry, terminal capacity 1,5 mm ²
Function :	NO contact

PS1-P

Fixed trip pressure :	≤1,3 bar
Adjustable trip pressure :	2 to 5 bar
Nominal thermal rating :	10 A
Max. operating frequency :	10 Hz
Nominal insulation voltage :	660 V AC or V DC
Protection degree :	IP 40
Function :	Open/Closed contact

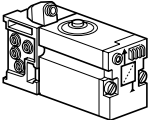

Step modules

Type	Symbol	Logic function	Description	Connection	Weight kg	Order code
		Visual indication of pneumatic output and manual override	With PSB-A12 sub-base	Ø4 mm Swivel push-in	0,175	PSM-A12 *
		Without manual override	With PSB-A12 sub-base	Ø4 mm Swivel push-in	0,170	PSM-B12 *

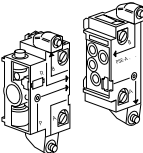
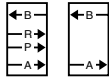
Set of head and tail modules

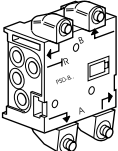

Type	Symbol	Logic function	Connection	Weight kg	Order code
		Ø6 mm Swivel push-in connection	Ø4 mm Swivel push-in	0,080	PSE-A12

Deviation modules

Type	Symbol	Logic function	Connection	Weight kg	Order code
		Used for parallel, optional, repeat sequenses and skip step	Ø4 mm Swivel push-in	0,050	PSD-A12
		for the remote reset of the last step module		0,050	PSD-B12

* ATEX version available Order code example : **PSM-A12-EX**

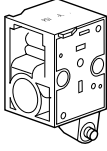

Additional step module interlock

Type	Symbol	Logic function	Connection ⁽¹⁾ connection	Weight kg	Order code
		May be mounted between the sub-base and the step module to interrupt the sequence if a sensor is found to be faulty	Ø4 mm Swivel push-in	0,045	PSV-A12 *

(1) For other type of connections contact Technical Sales Department

Step module without sub-base

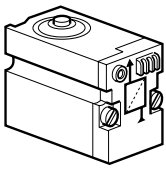
To be used with PSB-A12 sub-bases



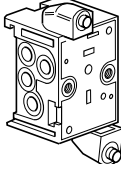

Type	Symbol	Logic function	Description	Weight kg	Order code
		Visual indication of pneumatic output	With manual override	0,135	PSM-A10 *
			Without manual override	0,130	PSM-B10

Step module sub-base

Type	Description	Connection ⁽¹⁾	Weight kg	Order code
	Sub-base	Ø4 mm Swivel push-in	0,040	PSB-A12

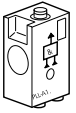

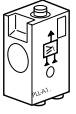
(1) For other type of connections contact technical sales Technical Sales Department

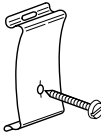
Main data for Line mounted elements

Type	Symbol	Logic function	Description	Connection	Weight kg	Order code
		AND	Single module	Ø4 mm Straight push-in	0,07	PLL-A11 *
		OR	Single module	Ø4 mm Straight push-in	0,07	PLK-A11 *
		Screw and clip assembly	Enables line mounted logic elements to be attached to DIN rail (Sold per pack of 10)		0,02	PZM-L199



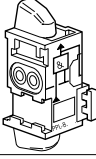
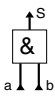
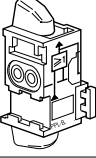
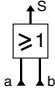
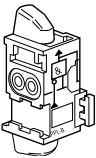
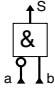
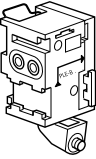



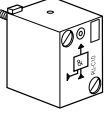

* ATEX version available Order code example : **PSV-A12-EX**

Main data for Combinable elements

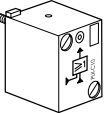
Type	Symbol	Logic function	Description	Connection ⁽¹⁾	Weight kg	Order code
		AND	With built-in key for combination and operating mode selection	Ø4mm Swivel push-in	0,08	PLL-B12 *
		OR	With built-in key for combination and operating mode selection	Ø4mm Swivel push-in	0,08	PLK-B12 *
		NOT	With built-in key for combination and operating mode selection	Ø4mm Swivel push-in	0,08	PLN-B12 *
		INPUT	With built-in key for combination, clip for mounting on DIN rail and blanking plate for closing a bank of combined elements	Ø4mm swivel push-in	0,08	PLE-B12

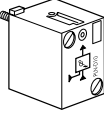
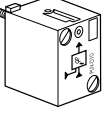

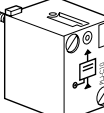

(1) For other type of connections contact Technical Sales Department

Main data for Sub-base mounted element

Type	Symbol function	Logic	Description	Weight kg	Order code
(For use with 3 port sub-base, type PZU•• please see page 18)					
		AND	With visual indication of pneumatic output signal	0,03	PLL-C10 *
		OR	With visual indication of pneumatic output signal	0,03	PLK-C10 *
		NOT inhibit standard	With visual indication of pneumatic input/output signal	0,03	PLN-C10 *
		NOT inhibiton	With visual indication of pneumatic input/output signal threshold	0,03	PLN-D10 *
		YES regenerate	With visual indication of pneumatic input/output signal	0,03	PLJ-C10 *

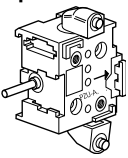
* ATEX version available Order code example : **PLL-B12-EX**

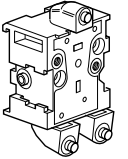
Sub base mounted elements

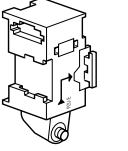
Type	Symbol	Logic function	Description	Connection ⁽¹⁾	Weight kg	Order code
3-port sub-bases (2) 			With common input	Ø4 mm Swivel push-in	0,04	PZU-A12
			Cascade	Ø4 mm Swivel push-in	0,05	PZU-C12
4-port sub-bases (2) 			For combination with memory relay (see next page) and amplifier relay (see next page)	Ø4 mm Swivel push-in	0,05	PZU-B12
Input module 				Ø4 mm Swivel push-in	0,05	PZU-E12

(1) For other type of connections contact Technical Sales Department (Ex : M5 connection = PZU-E15)

(2) Can be used singly or in combination. Mounting methods: On DIN rail with built in clip, on surface mounting using screws M4x25

Main data for time delay relays

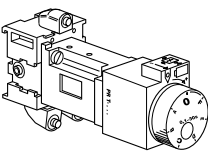
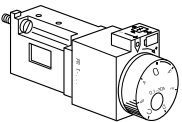



Type	Function	Timing range	Connection ⁽¹⁾	Weight kg	Order code
Complete with sub-base PZU-A12 	Output after timed period	0,1 to 30 s	Ø4 mm Swivel push-in	0,17	PRT-A12 *
Without sub-base For sub-base PZU-A12 or PZU-C12 	Output after timed period	0,1 to 3 s		0,13	PRT-E10 *
		0,1 to 30 s		0,13	PRT-A10 *
		10 to 180 s		0,13	PRT-B10 *
	Output during timed period (3)	0,1 to 3 s		0,13	PRT-F10 *
		0,1 to 30 s		0,13	PRT-C10 *
		10 to 180 s		0,13	PRT-D10 *
Tamper proof cap				0,01	LA9-D901

* ATEX version available Order code example : **PZU-A12-EX**



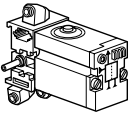

(1) For other type of connections contact Technical Sales Department

(3) Can be used to provide an impulse generator



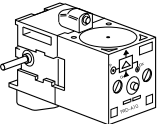

Main data for Memory relays

Type	Symbol	Description	Connection ⁽¹⁾	Weight kg	Order code
Complete with sub-base PZU-B12 		With priority reset signal and visula indication With manual override	Ø4 mm Swivel push-in	0,19	PLM-A12 *
Without sub-base For sub-base PZU-B12 		With priority reset signal and visulal indication With manual override		0,14	PLM-A10 *
		Without manual override		0,13	PLM-B10

Main data for Amplifier relays

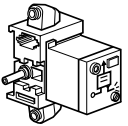
Type	Symbol	Description	Connection ⁽¹⁾	Weight kg	Order code
Complete with sub-base PZU-B12 		This relay is used to amplify the low pressure signal provided by a fluidic proximity sensor to a useable level With manual override	Ø4 mm Swivel push-in	0,18	PRD-A12 *
Without sub-base For sub-base PZU-B12 		This relay is used to amplify the low pressure signal provided by a fluidic proximity sensor to a useable level With manual override		0,13	PRD-A10 *

Main data for Sensor relays

Type	Symbol	Description	Connection ⁽¹⁾	Weight kg	Order code
Complete with sub-base PZU-A12 		This relay is used to provide a supply to a bleed sensor and to generate a pneumatic signal equal to its supply pressure	Ø4 mm Swivel push-in	0,07	PRF-A12 *
Without sub-base For sub-base PZU-A12 or PZU-C12 		This relay is used to provide a supply to a bleed sensor and to generate a pneumatic signal equal to its supply pressure		0,03	PRF-A10 *

* ATEX version available Order code example : **PLM-A12-EX**

(1) For other type of connections contact your Technical Sales Department



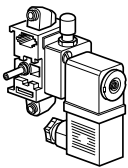
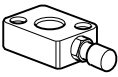
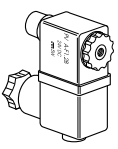



Main data for Solenoid actuators

Type	Symbol	Voltage	Load	Connection	Weight kg	Order code
Complete units, solenoid and cable plug						
		24 V ~ 50/60 Hz	8,5 VA	Manual override	22 mm Plug-in	0,17 PRS-A121B
		24 V	6 W	Manual override	22 mm Plug-in	0,17 PRS-A122B
		115 V ~ 50 Hz 120 V ~ 60 Hz	8,5 VA	Manual override	22 mm Plug-in	0,17 PRS-A121F
		230 V ~ 50 Hz 240 V ~ 60 Hz	8,5 VA	Manual override	22 mm Plug-in	0,17 PRS-A121M
Solenoid mounting base						
		For mounting the solenoid coil and plunger on 3-port modular sub-bases type PZU-A••, see page 18		Manual override	0,09	PRS-D10
Solenoid coil						
with plunger and 22 mm plug-in connector (4) 		24 V*	6 W		0,135	PVA-F102B
		48 V*	6 W		0,135	PVA-F102E
		24 VAC 50/60 Hz	8,5 VA		0,135	PVA-F101B
		48 VAC 50/60 Hz	8,5 VA		0,135	PVA-F101E
		115 VAC 50 Hz/ 120 VAC 60 Hz	8,5 VA		0,135	PVA-F101F
		230 VAC 50 Hz	8,5 VA		0,135	PVA-F101M
		240 VAC 60 Hz				
		255 VAC 50 Hz	8,5 VA		0,135	PVA-F101U

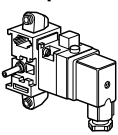

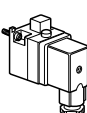

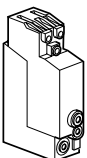
* Versions available for operation in explosive atmospheres.
 - Conforming to certificate LCIE 866115X
 - Electrical equipment conforming to harmonised European standards

EN 50014 dated March 1977 (NFC 23514 dated May 1982)
 EN 50019 dated March 1977 (NFC 23519 dated May 1982)
 - Referencing code EExe II T4 (consult Technical Sales Department)
 (4) Can be fitted with LED indicator and suppression, PVA•ZF••

Main data for Pressure switches

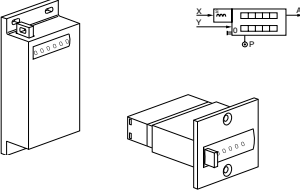
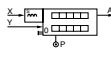
Type	Symbol	Electrical characteristics	Pneumatic characteristics	Connection	Weight kg	Order code
Complete unit with sub-base, solenoid and cable plug						
		N/O contact	override	Manual Plug-in	22 mm Ø4 mm Swivel push-in	0,13 PRE-A12
Without sub-base						
		N/O contact		Manual override	22 mm Plug-in Ø4 mm Swivel push-in	0,04 PRE-A10
Line mounted						
		1 CO contact 5 A/250 V	Fixed operating threshold	Manual override	Ø4 mm Push-in	0,05 PS1-P1081
		1 CO contact 5 A/250 V	Adjustable operating threshold	Manual override		

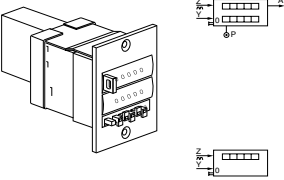
Main data for Impulse counters

Type	Symbol	Type	Counting range	Mounting	Weight kg	Order code	
Totalling counters							
	 	Pneumatic or manual reset	0 - 999 999	Surface mounting	0,08	PCT-A11	
					Flush mounting	0,06	PCT-B11
Pre-selection counters							
	 	Additional with pneumatic or manual reset	0 - 99 999	Flush mounting	0,12	PCP-A11	
		Auto reset	0 - 99 999	Flush mounting			PCP-A111
		Subtraction with pneumatic or manual reset	0 - 99 999	Flush mounting	0,11	PCP-S11	

Binary counters

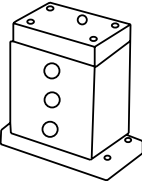
Type	Description	Weight kg	Order code
	Pneumatic actuated	0,650	2147900
	Electrical actuated	0,775	2147950

Main data for Timers

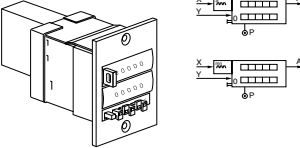
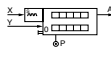
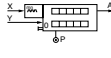
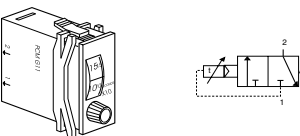
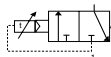
Type	Symbol	Type	Time base	Time range	Weight kg	Order code	
Digital display							
	 	With pneumatic or manual reset	1 second	1 second to 27 hours	0,20	PCM-A11	
				1 minute	1 minute to 69 days	0,20	PCM-B11
				2 minutes	3 to 100 minutes	0,20	PCM-E11
Calibrated dial							
			1 second	2 to 30 seconds	0,05	PCM-F11	
			1 second	20 to 300 seconds	0,05	PCM-G11	

Mounting bezels

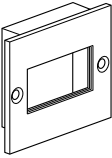
Type	Description	Weight kg	Order code
	For PCM-F11 and PCM-G11 mounting in 60 x 75 mm cut-out	0,015	PXC-ZM6075
	For PCM-F11 and PCM-G11 mounting in 72 x 72 mm cut-out	0,015	PXC-ZM7272

Bezels for DIN rail mounting

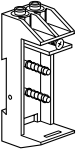
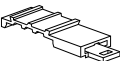
Type	Description	Weight kg	Order code
	For (non-reversible) clip-on mounting of PCM-F11 and PCM-G11 on push-in connection sub-base	0,020	PXC-ZA35
	35 mm DIN rail latching device for PXC-ZA35 sub-bases	0,010	PXC-ZE35

Lockable cover

Degree of protection IP 55

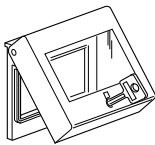
Type	Description	Weight kg	Order code
	Transparent cover key lockable for 60x75 bezel for PCP-A11, PCP-S11, PCP-MA11, PCP-MB11	0,025	PXC-B1
	For PCT-B11	0,018	PXC-A1

Seals for step modules and additional interlock modules

Type	Base component	Weight kg	Order code
1 set of 10 flat seals	PSM-A12 PSM-B12 PSV-A12 PSB-A12	0,038	PPR-L01

For logic elements and relays for mounting on modular sub-bases

Type	Base component	Weight kg	Order code
1 lot of 100 O-ring seals comprising : - 10 seals for ports with inputs filters - 90 seals for ports without input filter	PLJ-C10 PLK-C10 PLL-C10 PLN-C10 PLN-D10 PRT- . . PRF-A10	0,015	PPR-L04

For amplifier relays

Type	Base component	Weight kg	Order code
1 lot of 10 Mylar diaphragms	PRD-A10 PRD-A12	0,004	PPR-L08

Base usage - Shows which components can be mounted with which base types

Element	Order code	Type	2-Port	3-Port	4-Port	6-Port	
		Stacking		PZU-A12	PZU-B12	PSA-B12	
		Stacking		PZU-C12			
		Inline	BNC3P20	BNC3P10			
		Inline	BPB3P20	BPB3P10			
Step Module							
Step Module with Overrides	PSM-A10					X	
Step Module without Override	PSM-B10					X	
Logic							
AND	PLL-C10			X			
OR	PLK-C10			X			
YES	PLJ-C10			X			
NO	PLN-C10			X			
Threshold NOT	PLN-D10			X			
Relays							
Sensor	PRF-A10			X			
Solenoid	PRS-A10		X	X			
Electric Pressure Switch	PRE-A10			X	X		
E/P Pressure Switch	LNOTPS10			X			
Electric Pressure switch	LPS10		X	X			
Vacuum / Electric	LPSV10		X	X			
Timers							
Timer (NNP) Relay	PRT-A10		X*	X			
Timer (NNP) Relay	PRT-B10		X*	X			
Timer (NNP) Relay	PRT-E10		X*	X			
Timer (NNP) Relay	PRT-C10		X*	X			
Timer (NNP) Relay	PRT-D10		X*	X			
Timer (NNP) Relay	PRT-F10		X*	X			
Other Relays							
Memory Relay	PLM-A10			X	X		
Amplifier Relay	PRD-A10			X	X		

* Functionality must be checked.

Fitting color code

Port	Label		Color
Supply	P	2	Black / None
Signal	a	1	Green
Output	S	3	Red

Sequencer input power modules

	Entry Module	Head / Tail
Used with Base	PZU-E12	PSE-A12 *
	PZU-A12	PSB-A12 **
	PZU-C12	
	PZU-B12	

* PSE-A12-**EX** (ATEX version)

* PSE-A12**7** (U.S. version)

** PSB-A12-**EX** (ATEX version)

Dimensions, Logic processing

Modular sequencer

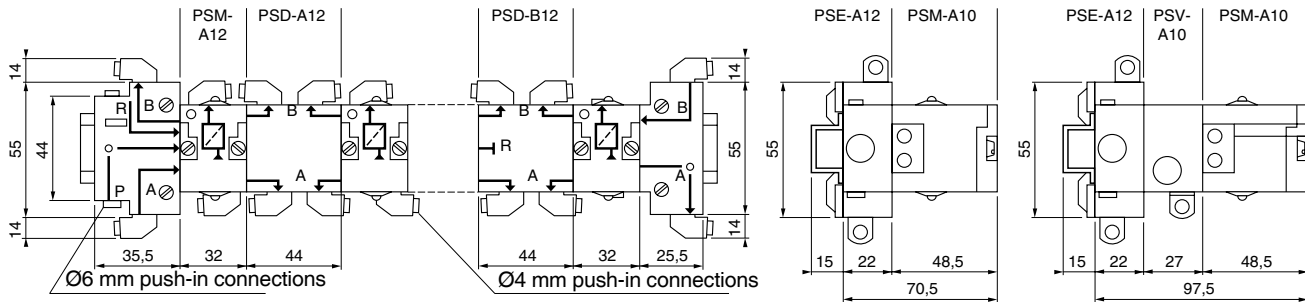

Line mounted logic elements

PLL-A11 and PLK-A11

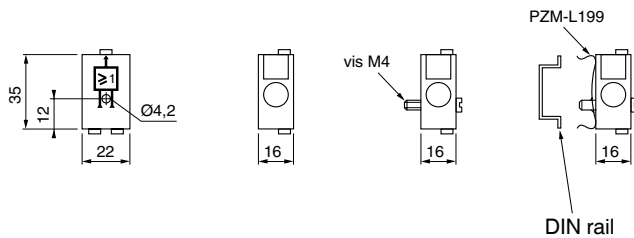

Combinable logic elements

PLE-B12 — PLL-B12 — PLK-B12 and PLN-B12

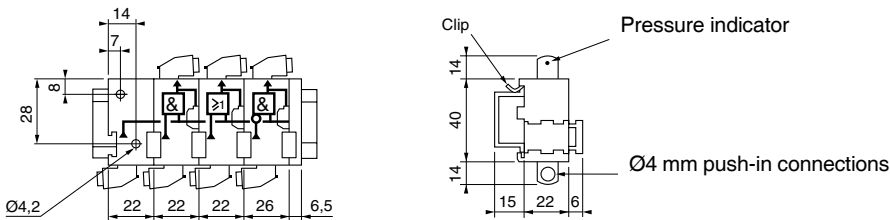

Logic elements mounted on 3-port modular sub-bases

PZU-E12

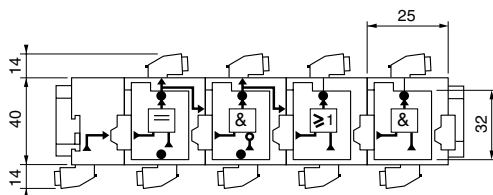

PLJ-C10 — PLN-C10 — PLK-C10 and PLL-C10 mounted on PZU-C12 and PZU-A12

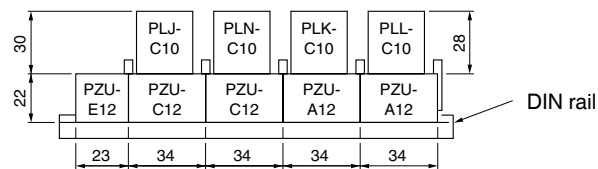

3 and 4-port modular sub-bases
 PZU-E12 — PZU-C12 — PZU-A12

PZU-B12

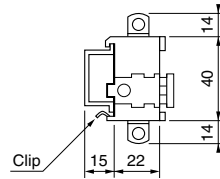
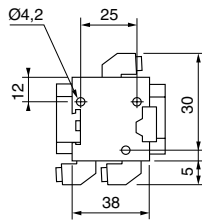
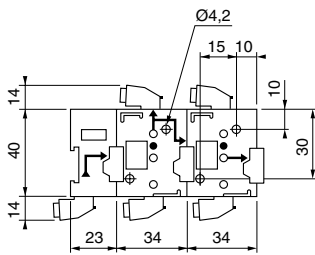

Relays mounted on 3-port modular sub-bases
 PRT-A12 — PRF-A12 — PRE-A12 — PRS-A121 and PLN-D12

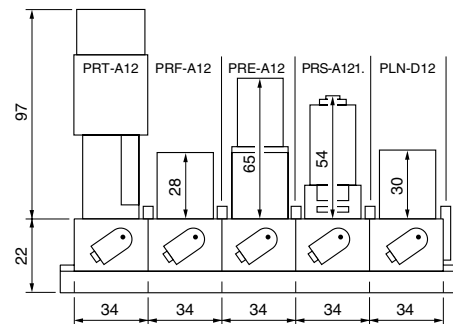
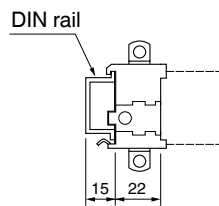
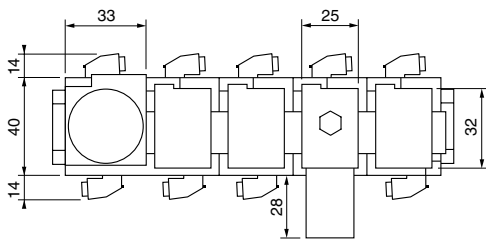

Relays mounted on 4-port modular sub-bases
 PLM-A12 and PRD-A12

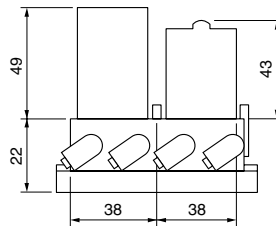
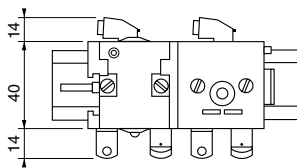

Pressure switch
 PS1-P1091

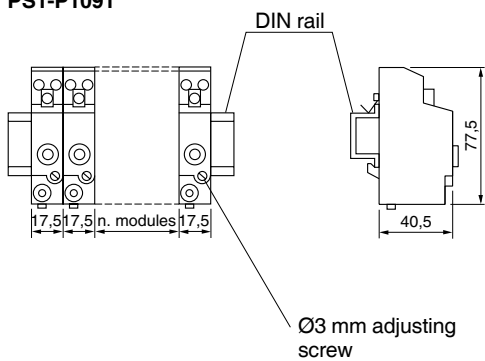

Totalising counters

PCT-A11 PCT-B11

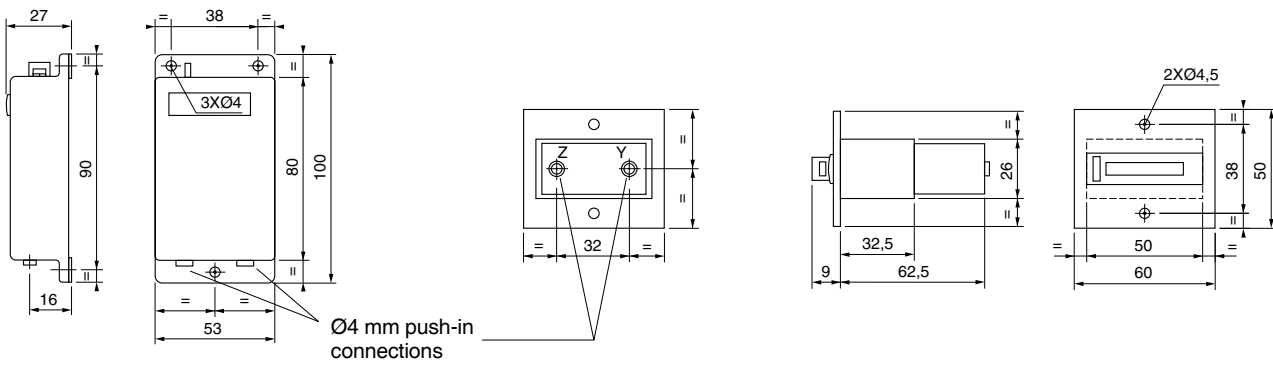

Preselection counters

PCP-A11 and PCP-S11

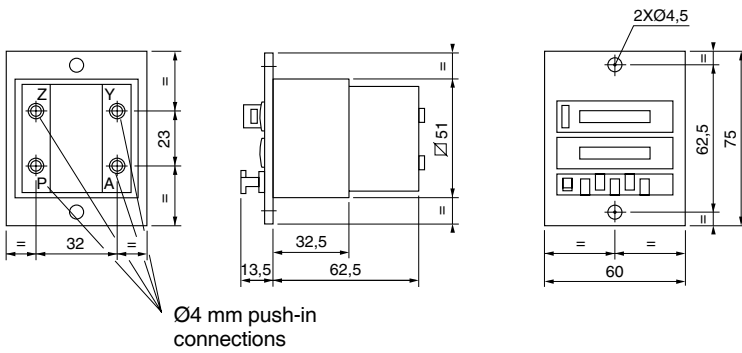

Binary counters

PCM-A11 and PCM-B11

2147900

2147950

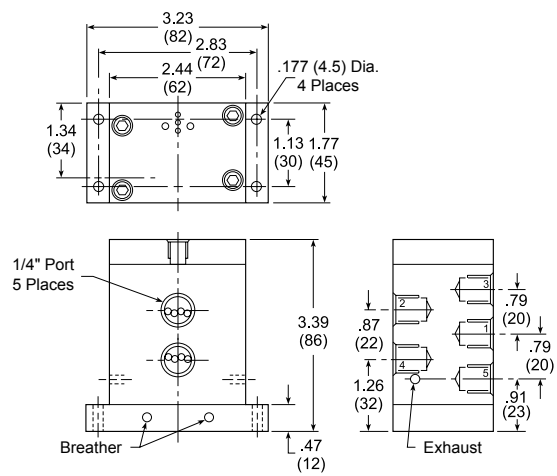
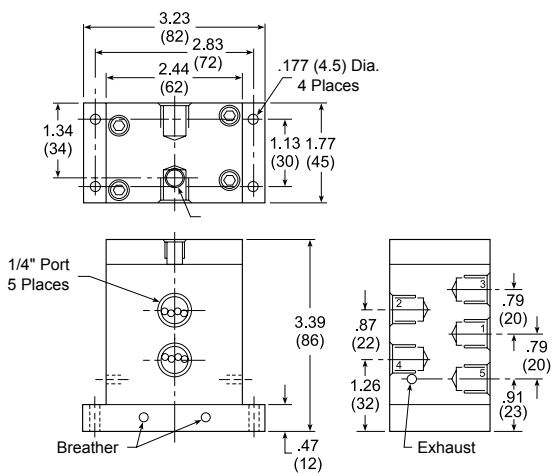

Digital display timers
PCM-A11 and PCM-B11

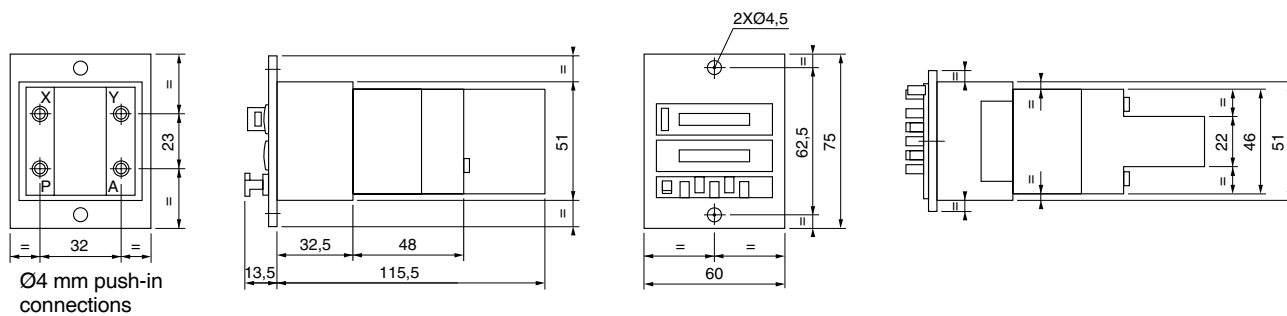

Timers with calibrated dial
PCM-F11 and PCM-G11

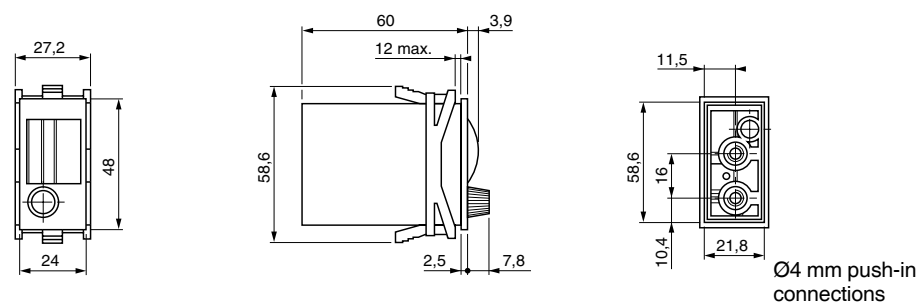

Parker Worldwide

AE – UAE, Dubai
Tel: +971 4 8127100
parker.me@parker.com

AR – Argentina, Buenos Aires
Tel: +54 3327 44 4129

AT – Austria, Wiener Neustadt
Tel: +43 (0)2622 23501-0
parker.austria@parker.com

AT – Eastern Europe, Wiener Neustadt
Tel: +43 (0)2622 23501 900
parker.easteurope@parker.com

AU – Australia, Castle Hill
Tel: +61 (0)2-9634 7777

AZ – Azerbaijan, Baku
Tel: +994 50 2233 458
parker.azerbaijan@parker.com

BE/LU – Belgium, Nivelles
Tel: +32 (0)67 280 900
parker.belgium@parker.com

BR – Brazil, Cachoeirinha RS
Tel: +55 51 3470 9144

BY – Belarus, Minsk
Tel: +375 17 209 9399
parker.belarus@parker.com

CA – Canada, Milton, Ontario
Tel: +1 905 693 3000

CH – Switzerland, Etoy
Tel: +41 (0) 21 821 02 30
parker.switzerland@parker.com

CL – Chile, Santiago
Tel: +56 2 623 1216

CN – China, Shanghai
Tel: +86 21 2899 5000

CZ – Czech Republic, Klecany
Tel: +420 284 083 111
parker.czechrepublic@parker.com

DE – Germany, Kaarst
Tel: +49 (0)2131 4016 0
parker.germany@parker.com

DK – Denmark, Ballerup
Tel: +45 43 56 04 00
parker.denmark@parker.com

ES – Spain, Madrid
Tel: +34 902 330 001
parker.spain@parker.com

FI – Finland, Vantaa
Tel: +358 (0)20 753 2500
parker.finland@parker.com

FR – France, Contamine s/Arve
Tel: +33 (0)4 50 25 80 25
parker.france@parker.com

GR – Greece, Athens
Tel: +30 210 933 6450
parker.greece@parker.com

HK – Hong Kong
Tel: +852 2428 8008

HU – Hungary, Budapest
Tel: +36 1 220 4155
parker.hungary@parker.com

IE – Ireland, Dublin
Tel: +353 (0)1 466 6370
parker.ireland@parker.com

IN – India, Mumbai
Tel: +91 22 6513 7081-85

IT – Italy, Corsico (MI)
Tel: +39 02 45 19 21
parker.italy@parker.com

JP – Japan, Tokyo
Tel: +(81) 3 6408 3901

KR – South Korea, Seoul
Tel: +82 2 559 0400

KZ – Kazakhstan, Almaty
Tel: +7 7272 505 800
parker.easteurope@parker.com

LV – Latvia, Riga
Tel: +371 6 745 2601
parker.latvia@parker.com

MX – Mexico, Apodaca
Tel: +52 81 8156 6000

MY – Malaysia, Shah Alam
Tel: +60 3 7849 0800

NL – The Netherlands, Oldenzaal
Tel: +31 (0)541 585 000
parker.nl@parker.com

NO – Norway, Ski
Tel: +47 64 91 10 00
parker.norway@parker.com

NZ – New Zealand, Mt Wellington
Tel: +64 9 574 1744

PL – Poland, Warsaw
Tel: +48 (0)22 573 24 00
parker.poland@parker.com

PT – Portugal, Leca da Palmeira
Tel: +351 22 999 7360
parker.portugal@parker.com

RO – Romania, Bucharest
Tel: +40 21 252 1382
parker.romania@parker.com

RU – Russia, Moscow
Tel: +7 495 645-2156
parker.russia@parker.com

SE – Sweden, Spånga
Tel: +46 (0)8 59 79 50 00
parker.sweden@parker.com

SG – Singapore
Tel: +65 6887 6300

SK – Slovakia, Banská Bystrica
Tel: +421 484 162 252
parker.slovakia@parker.com

SL – Slovenia, Novo Mesto
Tel: +386 7 337 6650
parker.slovenia@parker.com

TH – Thailand, Bangkok
Tel: +662 717 8140

TR – Turkey, Istanbul
Tel: +90 216 4997081
parker.turkey@parker.com

TW – Taiwan, Taipei
Tel: +886 2 2298 8987

UA – Ukraine, Kiev
Tel: +380 44 494 2731
parker.ukraine@parker.com

UK – United Kingdom, Warwick
Tel: +44 (0)1926 317 878
parker.uk@parker.com

US – USA, Cleveland
Tel: +1 216 896 3000

VE – Venezuela, Caracas
Tel: +58 212 238 5422

ZA – South Africa, Kempton Park
Tel: +27 (0)11 961 0700
parker.southafrica@parker.com

European Product Information Centre
Free phone: 00 800 27 27 5374
(from AT, BE, CH, CZ, DE, DK, EE, ES, FI,
FR, IE, IL, IS, IT, LU, MT, NL, NO, PL, PT, RU,
SE, UK, ZA)

